

3-1999

Interoperability Cost Analysis of the U.S. Automotive Supply Chain

Smita B. Brunnermeier
Research Triangle Institute

Sheila A. Martin
Research Triangle Institute, sheilam@pdx.edu

Let us know how access to this document benefits you.

Follow this and additional works at: <http://pdxscholar.library.pdx.edu/metropolitianstudies>



Part of the [Urban Studies and Planning Commons](#)

Citation Details

Tasse, Gregory, Smita B. Brunnermeier, and Sheila A. Martin. "Interoperability cost analysis of the US automotive supply chain." Research Triangle Institute (1999).

This Technical Report is brought to you for free and open access. It has been accepted for inclusion in Institute of Portland Metropolitan Studies Publications by an authorized administrator of PDXScholar. For more information, please contact pdxscholar@pdx.edu.

RESEARCH TRIANGLE INSTITUTE



March 1999

Interoperability Cost Analysis of the U.S. Automotive Supply Chain

Final Report

Prepared for

Gregory Tasse, Ph.D.
National Institute of Standards and Technology
Bldg. 101, Room A1013
Gaithersburg, MD 20899-1060

Prepared by

Smita B. Brunnermeier
Sheila A. Martin
Research Triangle Institute
Center for Economics Research
Research Triangle Park, NC 27709

RTI Project Number 7007-03

RTI Project Number
7007-03

Interoperability Cost Analysis of the U.S. Automotive Supply Chain

Final Report

March 1999

Prepared for

Gregory Tasse, Ph.D.
National Institute of Standards and Technology
Bldg. 101, Room A1013
Gaithersburg, MD 20899-1060

Prepared by

Smita B. Brunnermeier
Sheila A. Martin
Research Triangle Institute
Center for Economics Research
Research Triangle Park, NC 27709

Acknowledgments

We would like to acknowledge the assistance of contacts in the U.S. automotive supply chain who provided information for this study. We also received assistance from Dr. Thomas A. Phelps, of the Environmental Research Institute of Michigan; Dr. Gregory Tassej of NIST; Dr. Simon Frechette of NIST; and Dr. James Fowler of NIST.

Contents

Executive Summary	ES-1
1. Introduction	1-1
1.1 Background.....	1-3
1.2 Objectives	1-5
1.3 Project Scope	1-6
1.4 Report Organization.....	1-7
2. The Automotive Supply Chain	2-1
2.1 The Anatomy of an Automobile.....	2-1
2.1.1 Automobile Platforms and Models	2-2
2.1.2 Production by Platform	2-5
2.2 The Automobile Design and Development Process.....	2-9
2.2.1 Concept Design	2-10
2.2.2 Product Design	2-12
2.2.3 Process or Factory Design.....	2-12
2.3 The U.S. Automotive Supply Chain	2-12
2.3.1 OEMs	2-14
2.3.2 First-Tier Suppliers.....	2-16
2.3.3 Subtier Suppliers.....	2-17
2.3.4 Tooling Suppliers.....	2-17
3. Technical Issues in Product Data Exchange	3-1
3.1 Information Flow in the Automotive Supply Chain.....	3-1
3.1.1 Data Exchange Process	3-2
3.1.2 Data Exchange Problems	3-5

3.1.3	Data Quality Issues.....	3-7
3.2	Potential Methods for Improving Interoperability	3-8
3.2.1	Data Translation Methodologies	3-8
3.2.2	Improving Product Data Quality	3-15
3.2.3	Role of NIST	3-16
4.	Estimating Interoperability Costs	4-1
4.1	The Economic Impact of Imperfect Interoperability.....	4-1
4.1.1	Cost Drivers and Cost Categories	4-2
4.1.2	Impact Measures	4-4
4.1.3	Quantifying Costs.....	4-5
4.2	Data Collection Procedures.....	4-7
4.2.1	Sampling Plan	4-7
4.2.2	Survey Instruments	4-9
4.2.3	Survey Implementation.....	4-10
5.	Cost Estimates	5-1
5.1	Interoperability Cost Estimates: The Cost Component Approach.....	5-2
5.1.1	Avoidance Costs.....	5-3
5.1.2	Mitigating Costs.....	5-7
5.1.3	Delay Costs	5-8
5.2	Interoperability Cost Estimates: The Aggregate Cost Approach.....	5-9
5.2.1	Aggregate Interoperability Costs.....	5-9
5.2.2	Aggregate Delay Costs.....	5-10
5.3	Summary and Discussion	5-10
6.	Market Barriers and Roles for NIST	6-1
6.1	Market Failure in the Development of Interoperability Solutions.....	6-2
6.1.1	Nonappropriability of Benefits	6-3
6.1.2	Technical and Market Risk.....	6-3
6.1.3	Need for Unbiased Expertise.....	6-4
6.2	Potential Future Roles for NIST.....	6-5
	References	R-1

Figures

Figure 2-1	Structure of an Automobile	2-3
Figure 2-2	The Automobile Design and Development Process	2-11
Figure 2-3	U.S. Automotive Supply Chain.....	2-14
Figure 3-1	Multiple CAD/CAM Systems Used in the Automobile Supply Chain	3-3
Figure 3-2	Generic Model of Data Exchange in the Product Development Process	3-4
Figure 3-3	General Motors' STEP/IGES Translation Process Flow for Wireframe and Surfaces	3-14

Tables

Table 2-1	OEM Platforms in North American Production, 1997	2-6
Table 2-2	“Big Three” Production, Sales, and Employees: 1997	2-15
Table 2-3	Characteristics of Prominent Selected First-Tier Suppliers	2-18
Table 2-4	Characteristics of Prominent Subtier Suppliers.....	2-19
Table 2-5	Characteristics of the Tool and Die Industry	2-20
Table 4-1	Interoperability Cost Drivers	4-3
Table 4-2	Metrics for Interoperability Costs.....	4-6
Table 5-1	Summary of Annual Interoperability Costs: Cost Component Approach.....	5-3
Table 5-2	Sources of Annual Avoidance Costs	5-4
Table 5-3	Summary of Annual Interoperability Costs: Aggregate Cost Approach.....	5-9

Executive Summary

Interoperability is the ability to communicate product data across different production activities. It is essential to the productivity and competitiveness of many industries because efficient design and manufacturing require the coordination of many different participants and processes that rely on a digital representation of the product.

The National Institute for Standards and Technology (NIST) is the only U.S. research laboratory or institute whose primary mission is supporting economic growth. As part of this mission, NIST provides technical infrastructure to U.S.-based industries. NIST's Manufacturing Engineering Laboratory (MEL) provides manufacturing infrastructure, technology, measurements, and standards. MEL is currently involved in developing standards that promote interoperability among members of the U.S. automotive supply chain.

The objective of this study was to assess the costs of imperfect interoperability to the U.S. automotive supply chain and to describe the sources of these costs. By understanding the sources and magnitude of inefficiencies caused by interoperability problems, NIST can better determine the potential impact of its programs and focus them to maximize program effectiveness.

This study estimates that imperfect interoperability imposes at least \$1 billion per year on the members of the U.S. automotive supply chain. By far, the greatest component of these costs is the resources devoted to repairing or reentering data files that are not usable for downstream applications. This estimate is conservative because we could not quantify all sources of interoperability costs.

ES.1 BACKGROUND

The productivity and competitiveness of the U.S. domestic automobile industry is important to the overall performance of the U.S. economy. The auto industry is responsible for about 9 percent of the total value of manufactured goods in the U.S. and 4 percent

of manufacturing employment (U.S. Department of Commerce, 1998). U.S. consumers spend about 5 percent of total personal expenditures on motor vehicles and parts (BEA, 1998). The motor vehicle industry is also a major end-user for many materials.

The trend toward concurrent engineering and outsourcing in the auto industry have elevated the importance of high-quality product data and efficient product data exchange (PDE).

A number of characteristics and trends in the auto industry have elevated the importance of interoperability to the productivity and competitiveness of the industry. In an attempt to protect market share from imports, the U.S. auto industry began in the 1970s to implement a number of practices designed to improve the industry's productivity and competitiveness. These practices include concurrent engineering and other lean manufacturing methods as well as outsourcing a greater share of design and development to suppliers. These methods have significantly reduced lead times and have narrowed the productivity gap between the U.S. industry and its competitors.

Changes in the structure of the U.S. automotive supply chain have accompanied these trends toward concurrent engineering and outsourcing. The U.S. automotive supply chain has become more complex and difficult to define. As shown in Figure ES-1, the U.S. automotive supply chain consists of four primary elements: original equipment manufacturers (OEMs), first-tier suppliers, sub-tier suppliers, and infrastructure suppliers. However, individual companies may operate in several different positions in the supply chain. A company may work for many customers and function as a first-tier supplier on one project and a sub-tier supplier on other projects.

These trends have elevated the importance of the quality of product data and its efficient exchange. Many individuals and companies participate in the design of an increasingly complex automobile; hence, the design process depends critically on team members' ability to share information about essential design elements. Digital representations of products and parts have largely replaced physical drawings as the form in which product data are stored, analyzed, and communicated among the people contributing to the design of an automobile. One OEM estimates that as many as 453,000 exchanges of product data occur each year within the company and among the company and its suppliers.

Figure ES-1. U.S. Automotive Supply Chain

The complexity of the U.S. automotive supply chain compounds the industry's interoperability problems.

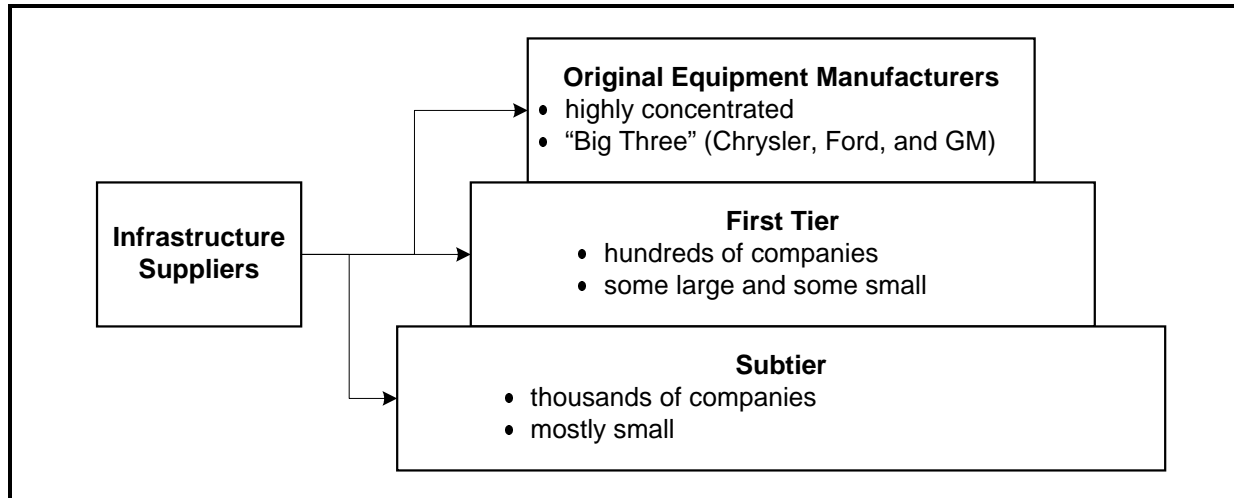

A number of problems arise when design data generated for one purpose are shared with other members of an automotive design team. Many different software and hardware systems are used throughout the automotive supply chain. These systems differ not only among companies but also among different functions within a company. Because each system has its own proprietary data representation, product data are created and stored in multiple, incompatible formats, which makes exchanging these data difficult. Resulting data files may contain errors, may be incomplete, or may be formatted in a way that makes them unusable for downstream applications.

Members of the auto industry generally acknowledge that imperfect interoperability is an important and expensive problem. A number of potential solutions have been developed over the years. These include

- standardization on a single system for each OEM and its suppliers and sharing of files in native format,
- development of point-to-point translators, and
- development of neutral format translators (Doty, 1994).

None of the solutions that have been widely used in the past have been successful at significantly reducing these problems. Single-system standardization forces suppliers to maintain redundant systems and does not eliminate interoperability problems. Point-to-

Standard for the Exchange of Product Model Data (STEP) is emerging as a promising solution to the interoperability problems in the automotive and other industries.

point translators work reasonably well for some well-defined data translation tasks, but each combination of sending and receiving systems requires a different translator. Neutral format translators such as IGES and DXF have been very successful in some limited applications, but they have a number of weaknesses.

However, an alternative neutral format is emerging as a promising solution to the interoperability problems in the automotive and other industries. The International Standards Organization (ISO) adopted Standard for the Exchange of Product Model Data (STEP) as ISO 10303 to support product data exchange, independent of proprietary vendor computer-aided design/computer-aided manufacturing (CAD/CAM) or other system formats. STEP is currently evolving to extend data exchange capabilities to all aspects of a product's life cycle, from material specification to after-sale maintenance. More than 38 countries are involved in developing STEP (APAA, 1998).

Several of STEP's application protocols have been incorporated into commercially available translators. Tests of the performance of STEP translators are demonstrating that STEP has the potential to significantly reduce many of the interoperability problems that now plague the industry.

NIST represents U.S. interests in developing STEP and is developing a number of tools to assist industry in implementing STEP, including methods and software for testing STEP translation software. NIST has also participated in pilot programs for implementing STEP as the data exchange standard in the automotive and other industries.

ES.2 METHODOLOGY

The automotive supply chain incurs several types of costs related to imperfect interoperability:

- ▶ avoidance costs,
- ▶ mitigating costs, and
- ▶ delay costs.

The automotive supply chain incurs several types of costs related to imperfect interoperability. Automakers incur *avoidance costs* to prevent technical interoperability problems before they occur.

Mitigating costs consist of the resources required to address interoperability problems after they have occurred. *Delay costs* arise from interoperability problems that delay the introduction of a new vehicle.

We employed two separate approaches to quantifying interoperability costs: the cost component approach and the aggregate cost approach. For the cost component approach, we

identified many sources of avoidance and mitigating costs and asked industry executives to identify the labor, capital, and materials devoted to addressing each of these problems separately. We also asked executives to estimate the cycle time delay caused by interoperability problems and developed a cost estimate associated with this delay. We summed these components of cost to arrive at an estimate of the total interoperability costs in the industry. This approach provided insight regarding the primary sources of interoperability costs.

Using the aggregate cost approach, we interviewed key industry executives about interoperability cost issues and to ask them to consider the scope of all interoperability problems in their company. We asked them to provide an estimate of total interoperability costs. We added cycle time delay costs to this estimate. This method allowed the respondents to consider cost components that we may not have considered. It also provided a method for checking the consistency of the responses.

Our results are based on interviews with representatives of ten companies: two of the “Big Three” auto OEMs, five suppliers, and three tooling companies. To add qualitative information from a slightly different perspective, we also discussed interoperability issues with one company that manufactures auto-related equipment.

ES.3 RESULTS

Imperfect interoperability imposes at least \$1 billion dollars per year on the members of the U.S. automotive supply chain.

Solving interoperability problems can significantly reduce costs for the U.S. automotive supply chain. Using the two different approaches described above, this study estimates that imperfect interoperability imposes at least \$1 billion dollars per year on the members of the U.S. automotive supply chain. The majority of these costs are attributable to the time and resources spent correcting and recreating data files that are not usable by those receiving the files. These estimates are conservative because they do not include elements of cost that our industry contacts could not quantify.

Table ES-1 shows our estimates using both the cost component approach and the aggregate cost approach. The estimates differ by

Table ES-1. Summary of Interoperability Costs
Two approaches to estimating interoperability costs lead to similar estimates.

Source of Cost	Total Cost (\$Thousands)	Percent of Cost
<i>Cost Component Approach</i>		
Avoidance cost	52,799	5
Mitigating costs	907,645	86
Delay cost	90,000	9
Total	1,050,444	100
<i>Aggregate Cost Approach</i>		
Interoperability cost	925,602	91
Delay cost	90,000	9
Total	1,015,602	100

only 3 percent. The similarity of these estimates provides some assurance that the respondents to our survey were consistent with respect to their answers and provides evidence that the estimates are credible.

We consider this estimate of interoperability costs of the U.S. automotive supply chain to be conservative. The project's scope, time and resource constraints, and data limitations prevented us from quantifying several sources of interoperability costs. These include the following:

- **Post-manufacturing interoperability costs.** We considered only the interoperability costs involved in the design and manufacture of automobiles. Interoperability problems also occur during other phases of the product life cycle, including marketing, after-market product support, and cost analysis.
- **Interoperability costs of small suppliers.** Because of constraints on project time and resources, we quantified interoperability costs to the OEMs, large suppliers, and tooling suppliers. However, smaller suppliers may also incur some costs.
- **In-house investments in interoperability solutions.** Because of the unavailability of data, we were unable to quantify all of the industry's investments in the development of interoperability solutions. These investments may be substantial. For example, GM's investment in its STEP Translator Center is not included in our estimates.

- **Costs to consumers resulting from delays.** Interoperability problems delay the introduction of new and redesigned autos. Our estimates do not include consumers' welfare losses resulting from delays in the availability of new and improved products.
- **Loss of market share resulting from delays.** We hypothesized that the U.S. auto industry could suffer a loss of market share resulting from interoperability delays, which could lead to a loss of profits to the industry. We were not able to quantify these lost profits.

Industry has been slow to act on its own to invest in the most promising solutions to these costly interoperability problems. Despite industrywide agreement that a neutral format such as STEP holds the best potential solution to interoperability problems (McEwan, 1995), STEP has not been universally adopted by the industry. A number of issues have hampered industry's commitment to STEP, including

- the significant investment required to develop a solution that will benefit all members of the industry;
- the technical risk associated with developing STEP translators;
- the market risk caused by competitive rivalries among the companies that develop CAD/CAM software and translators; and
- the need for an unbiased expert to negotiate, develop, and implement industry standards.

NIST's STEP activities can improve the value of STEP to the U.S. economy.

NIST can address many of these issues to advance the development of STEP translators, to hasten the adoption of STEP by industry, and to improve the value of STEP to the U.S. economy. By assisting in the development of STEP as an industry standard, NIST reduces the uncertainty and risk associated with industry's investment in STEP. NIST's activities in developing conformance testing practices helps to improve the quality of the STEP software, further reducing the technical risk to both the software industry and the auto industry. By helping to demonstrate the benefits of STEP through programs such as the AutoSTEP pilot program, NIST helps to reduce industry's perceived technical risk associated with investments in STEP. Finally, by continuing to participate in the development of STEP's application protocols and implementation prototypes, NIST lends expertise and credibility to the STEP development process and improves the process of standards implementation.

The resources NIST invests in participating in these activities benefit the entire U.S. automotive supply chain by reducing costs, improving cycle time, and strengthening the competitiveness of the industry. U.S. consumers also benefit because cost savings are passed on and new models become available more quickly.

1

Introduction

The productivity and competitiveness of the U.S. domestic automobile industry is important to the overall performance of the U.S. economy. Motor vehicles and equipment account for about 9 percent of the total value of manufactured goods in the U.S. and 4 percent of manufacturing employment (U.S. Department of Commerce, 1998). In 1997, U.S. personal consumption expenditures on motor vehicles and parts were over \$250 billion, comprising about 5 percent of total personal consumption expenditures (BEA, 1998). Furthermore, the motor vehicle industry is a major end user for many key materials such as alloy steel, aluminum, and synthetic rubber and therefore creates a derived demand for additional economic activity (Womack, 1989).

During the 1960s, 1970s, and 1980s the U.S. automobile industry struggled as its domestic market share fell and the import share of the U.S. automobile market rose from less than 1 percent in 1955 to over 30 percent in 1987 (Womack, 1989). As the industry searched for explanations for the decline, analysts argued that the industry's production techniques were outdated (Womack, Jones, and Roos, 1990) and that its market strategies were not in tune with the rapidly changing motor vehicle market (Womack, 1989). As a result, U.S. automakers took longer to develop a new automobile and used more engineering hours in the product development process than their Japanese counterparts.

The U.S. auto industry has made significant improvements in the last decade. By increasing their use of concurrent engineering and other lean manufacturing methods and by delegating a greater

share of design and development to their suppliers, the average lead time for a new auto platform has fallen from about 5 years in the mid-1980s (Womack, 1989) to about 2 to 3 years today (Buckholz, 1996; Brooke, 1998; Jost, 1998; Martin, 1998). U.S. automakers have also made significant progress toward closing the productivity gap with their competitors (*Automotive News*, 1997b).

Concurrent engineering and design outsourcing have magnified the importance of efficient PDE and system interoperability.

Although concurrent engineering and design outsourcing have improved the competitiveness of the industry, these practices have also magnified the importance of efficient product data exchange (PDE). The responsibility for the design of an automobile and the factory that produces it is now distributed among many companies; thus, product data must be shared among a greater number of people and organizations, both concurrently and sequentially. This increased level of PDE implies that interoperability—the ability to communicate product data across different production activities—is essential to the productivity and competitiveness of the industry.

As the number of data exchanges increases, the costs of imperfect interoperability mount. U.S. automakers and their suppliers incur costs to maintain multiple computer-aided design (CAD)/computer-aided manufacturing (CAM) systems, to repair files that are translated incorrectly, to manually reenter data that cannot be translated, and to scrap designs and tooling that are defective because of imperfect interoperability.

Today, the U.S. automobile industry spends \$2 to \$3 billion developing a new automobile or truck platform.^{1,2} With as many as 12 major platform redesigns and eight minor redesigns per year,³ even a small percentage decrease in the cost of designing an automobile and its factory can lead to significant savings. These savings could be distributed among consumers, who would enjoy lower prices and earlier innovations in automobile designs, and the

¹A platform is the basic mechanical structure of the vehicle. Several car models can share the same platform.

²The 1999 GM Chevy Silverado cost about \$3 billion for vehicle and factory development while Chrysler's new Jeep Grand Cherokee cost about \$2.65 billion (Greenwald, 1998). Ford's Focus cost between \$2 to 3 billion (Sorge, 1998), and the Chrysler LH Concorde and Intrepid redesigns cost about \$2.1 billion (Jost, 1998).

³Research Triangle Institute (RTI) developed these estimates of the average number of platforms undergoing major and minor redesign from an IRN, Inc., report on plans for model year new product programs for 1996 to 2003 (IRN, 1997).

U.S. auto industry, which would incur fewer costs and capture a larger market share.

The National Institute of Standards and Technology (NIST) is assisting the auto industry in the development of solutions to interoperability problems. As the only U.S. federal research laboratory or institute whose primary mission is supporting economic growth, NIST provides technical infrastructure to U.S.-based industries. NIST is making a number of contributions to advancing interoperability in the U.S. automotive supply chain, including participation in the development and diffusion of a PDE standard.

The broad, economywide portfolio of technologies supported by NIST's infratechnologies creates a strategic planning challenge for NIST. In response, NIST requires economic assessments of technologies, industries, and market structure to

- project or document the returns from its laboratory research programs and
- provide information that it can use to improve the selection and management of its portfolio of projects.

This study furthers NIST's objectives for economic analysis by examining the cost of interoperability problems in the U.S. automotive supply chain. By understanding the sources and magnitude of inefficiencies caused by interoperability problems, NIST can better determine the potential impact of its programs and focus them to maximize their effectiveness.

1.1 BACKGROUND

In the process of designing and manufacturing an automobile, many individuals and organizations exchange product data. The design and manufacturing process involves many divisions within the original equipment manufacturer (OEM), many first-tier suppliers, a number of second-tier and sub-tier suppliers, and tooling suppliers. This exchange of data supports the process of concurrent engineering and design, allowing these organizations to work together to improve the performance and manufacturability of a product and to advance the competitiveness of the industry.

The number of people, organizations, and functions involved in producing an automobile increases the complexity of the data

exchange process. Digital representations of products and parts have largely replaced physical drawings as the form in which product data are stored, analyzed, and communicated among the people contributing to the design of an automobile. Many different software and hardware systems are used throughout the automotive supply chain. Not only do these systems differ between companies but they also differ among different functions within a company. Each system has its own proprietary data representation. As a result, product data are created and stored in multiple, incompatible formats. These incompatible formats cause imperfect interoperability among the parties involved in exchanging product data.

Imperfect interoperability imposes costs on the automobile industry due to higher costs of design and production and slower implementation of design changes.

Imperfect interoperability imposes costs on the industry due to higher costs of design and production and slower implementation of design changes. The OEMs have tried to improve interoperability, in part, by mandating specific software systems for their suppliers. These mandates sometimes impose significant costs, especially for suppliers that must maintain multiple systems to satisfy the demands of multiple customers. The systems are expensive to purchase and to learn. Data translators, another potential interoperability solution, currently have limited capabilities and can cause data translation errors.

An alternative neutral format for data translation is emerging as a promising solution to the interoperability problems in the automotive and other industries. The International Standards Organization (ISO) adopted Standard for the Exchange of Product Model Data (STEP) as ISO 10303 to support product data exchange, independent of proprietary vendor CAD/CAM or other system formats. STEP is currently evolving to extend data exchange capabilities to all aspects of a product's life cycle, from material specification to after-sale maintenance. More than 38 countries are involved in the development of STEP (APAA, 1998).

NIST is participating in the development of PDE standards, tools, and practices that help the private sector integrate those standards into commercial software.

NIST has been involved in developing the infratechnologies required to improve interoperability in the auto industry and other industries. NIST is playing a key coordinating role in ISO's development of STEP, is supporting conformance and implementation testing, and is developing modularization infrastructural technologies. These activities help the private sector integrate STEP into commercial software. To maximize the

effectiveness of its efforts and to develop an idea of the potential benefits of this work, NIST needs to better understand the magnitude and sources of the costs of this problem to the U.S. auto industry.

1.2 OBJECTIVES

The objective of this study is to estimate the cost of imperfect interoperability to the U.S. automotive supply chain and to describe the sources of those costs. While industry personnel generally agree that interoperability is an important and expensive problem, there is no comprehensive estimate of just how much this problem costs the industry. Even though a few case studies have been conducted of the economic impact of selected elements of cost (e.g., the Industrial Technology Institute [ITI] study of the cost of duplicate software [Fleischer, Nicholas, and Phelps, 1997]), the problem has not been examined in its entirety.

This study's focus is slightly different than typical studies of the economic impact of NIST laboratory programs. Most studies of this type (e.g., Leech and Link, 1995; Link, 1995) involve retrospective analyses of NIST programs that have contributed to the development of specific infratechnologies. This study is different because it is a prospective analysis of the potential benefits of a NIST program to address interoperability issues.

The concepts, procedures, and some of the findings from this study will be applicable to other industries, such as aircraft and shipbuilding, in which concurrent engineering is becoming an important part of the competitiveness strategy.

NIST also anticipates that the methods developed for this study will be useful in analyzing interoperability problems in other industries. Many industries face interoperability challenges similar to those of the auto industry. Although the auto industry is unique in some ways, the concepts, procedures, and some of the findings from this study will be applicable to other industries, such as aircraft and shipbuilding, in which concurrent engineering is becoming an important part of the competitiveness strategy.

This difference in focus reflects NIST's dual uses for the results of this study. By providing a rich characterization as well as an estimate of the magnitude of the cost of interoperability problems, the results of this study will contribute directly to NIST's strategic planning in the area of interoperability. This study will also provide the first step in analyzing the potential impact of NIST's interoperability programs for the U.S. automotive industry. The

total cost of imperfect interoperability provides an upper-bound estimate of the potential benefits of solving this problem and therefore an estimate of the maximum potential impact of NIST's contributions to solving the problem. This information can be used later in a retrospective study of the impact of NIST's interoperability programs.

With this information, NIST can assess how the costs of interoperability can be alleviated by addressing a variety of conditions that add to the cost of these problems. These conditions include the following:

- maintenance of redundant CAD/CAM systems;
- maintenance of multiple point-to-point translation software;
- manual reentry of digital data when translators are not available;
- errors in translation that are detected and either reattempted, repaired, or manually reentered;
- undetected translation errors that cause problems later in the design and manufacturing process; and
- delays due to translation problems that affect product development schedules.

By showing how the overall costs to the industry are driven by these factors, NIST will be able to focus on the conditions causing the greatest cost to the industry.

1.3 PROJECT SCOPE

The term product data denotes the totality of data elements which completely define the product for all applications over its expected life cycle (Smith, 1989).

This study addresses interoperability between engineering systems that exchange product data within the U.S. automotive supply chain. Product data include the geometry, topology, relationships, tolerances, attributes, and features necessary to completely define a component part or an assembly of parts for the purposes of design, analysis, manufacture, inspection, and product support. This study covers only the front end of the automobile's product life cycle.

That is, it does not address interoperability problems beyond product manufacturing. Thus, this study addresses

- interoperability between all engineering applications in the design-to-manufacture life cycle,
- interoperability within as well as across companies,
- data translation issues as well as data quality issues,

- interoperability problems that occur across different software applications as well as within the same software application, and
- instances in which product data must be manually entered into a software program because no interoperability exists between the receiving software and other software that already has the product data.

In practice, disentangling the effects of interoperability problems due to data quality problems from the impact of data translation issues is very difficult. Both of these problems have important effects on the cost of designing and manufacturing an automobile. Thus, rather than trying to address these issues separately, we explored the cost of both kinds of interoperability issues.

1.4 REPORT ORGANIZATION

Section 2 provides background information on the auto industry. This information illustrates why imperfect interoperability can impose significant costs to the auto industry and consumers. Section 3 describes the technical problems that cause imperfect interoperability in the auto industry and discusses how these problems might be avoided. Section 4 describes how imperfect interoperability affects costs and profits of members of the U.S. automotive supply chain as well as consumer benefits. It also discusses the development of metrics of technical and economic impact and our procedures for collecting the data required to construct these metrics. Section 5 presents our analysis of primary and secondary data sources and provides our estimate of the cost of imperfect interoperability to the U.S. automotive industry and its consumers. Section 6 discusses market barriers to the adoption of interoperability solutions and explains how NIST can assist industry in overcoming those barriers.

2

The Automotive Supply Chain

Interoperability issues in the automotive industry are important because the complexity of the product, the design process, and the industry magnifies the impact of interoperability problems while obscuring their solution.

The design and production of an automobile require interaction and coordination among many functions and industry participants. An automobile consists of a large number of components, parts, and accessories that must function together as an integrated unit. Consequently, the design and development process is also complex, requiring a number of iterations among the design steps for different vehicle components. To further complicate the process, these components are typically designed and manufactured by many companies that are part of a complex supply chain. These companies must somehow coordinate their activities to ensure that the components they design and manufacture are compatible with other components.

The complexity described in this section suggests the importance of efficient and accurate product data exchange (PDE).

Interoperability issues in the automotive industry are important because the complexity of the product, the design process, and the industry magnifies the impact of interoperability problems while obscuring their solution. This section describes the complexity leading to the importance of interoperability issues and why interoperability issues have become an important factor in the competitiveness of the automobile industry.

2.1 THE ANATOMY OF AN AUTOMOBILE

The structure of an automobile is extremely complex. A typical motor vehicle consists of approximately 15,000 parts and accessories that must be designed to be compatible. As shown in

Figure 2-1, an automobile comprises several major systems, each of which contains many subsystems, components, and interfacing parts. For example, parts such as bearings, crankshafts, filters, gears, pistons, pumps, and valve trains make up the engine, and their design must be compatible. Similarly, other systems, such as axles, suspensions, transmissions, bodies, seats, and instrument panels, consist of many parts that must work together. Designers must coordinate these systems to enable the successful final assembly of the vehicle.

2.1.1 Automobile Platforms and Models

Automakers are increasing the flexibility of their platforms to reduce development and engineering costs and to speed the introduction of new models.

Most motor vehicles are designed and built under the platform concept. A platform is typically defined as the basic mechanical structure of a vehicle. Different vehicles based on the same platform commonly share several structural elements, such as the floor plan and door pillar (*Automotive News*, 1997a). Typically, automakers offer several car models per platform. For example, the Chevrolet Lumina, Chevrolet Monte Carlo, Pontiac Grand Prix, Buick Regal, and Buick Century all share the same platform. In addition, these cars may be offered in several body styles, such as a two-door coupe, four-door sedan, and four-door hatchback.

The platform concept is becoming increasingly important as automakers seek to reduce costs by designing and producing more vehicles from common platforms. The number of platforms is an important measure of annual design and engineering effort of each company. Models built on common platforms carry over a large percentage of parts and production processes, and the engineering and tooling for the vehicle's basic structure account for the majority of total product development and launch costs (Womack, 1989). Thus, the potential savings from using an existing platform for a new model are considerable. Ford estimates that when they develop a new model on an existing platform, development and engineering costs fall by 15 to 20 percent (*Automotive News Europe*, 1997). Other automakers estimate even higher savings.

Most automakers are now pursuing a strategy of reducing the number of platforms but increasing their flexibility and the number of models that can be developed from each platform. The strategy

Figure 2-1. Structure of an Automobile
 An automobile consists of several major systems; each system contains a number of components and parts.

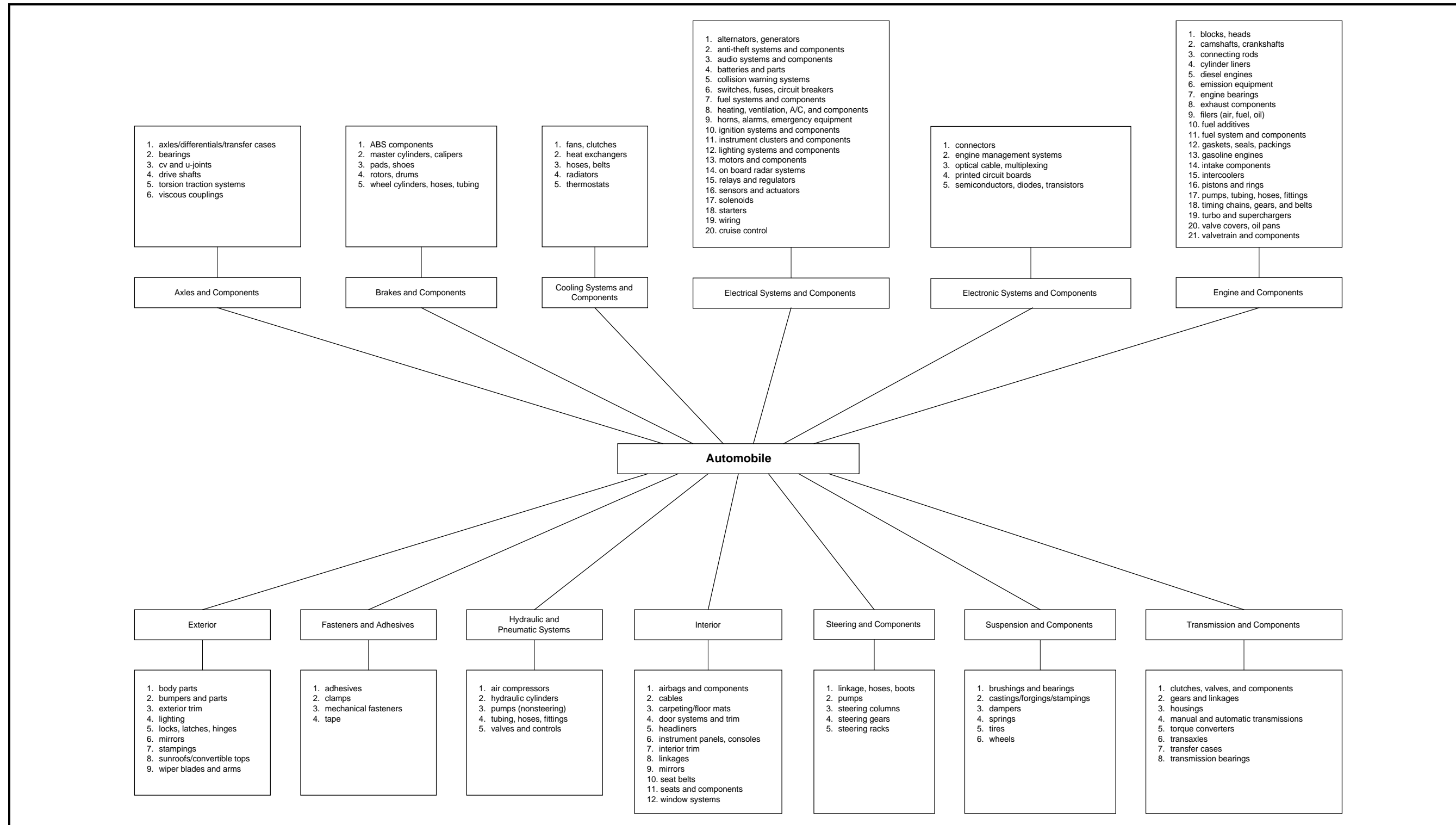

Source: constructed from data available from Chilton Company. 1997. "Automotive Industries Annual Source Guide." Available at <<http://ai.chilton.net>>.

allows automakers to offer consumers model variety while reducing design and development costs.

At the same time, the definition of a platform is changing. A platform once included the floor plan architecture, sometimes even with fixed door openings and front and rear window frames. Lately, the definition of a platform is much broader, allowing for differences in wheelbase and even width (*Automotive News Europe*, 1997). This broader definition allows automakers to design and build a greater variety of models on the same platform.

Table 2-1 lists the platforms used in North American production by the U.S. original equipment manufacturers (OEMs) in 1997 (IRN, 1997). This classification uses a somewhat narrow definition of a platform. The average number of models per platform is about two. However, the number of models for each platform varies greatly, and this number should rise as the OEMs pursue their strategy of fewer platforms with greater flexibility.

2.1.2 Production by Platform

Maximizing unit production and sales per platform is an important industry strategy for decreasing design and development costs over the next decade (*Auto and Auto Parts*, January 9, 1997). Table 2-1 lists the U.S. and Canadian production of the most popular groupings of U.S. OEM platforms for the 1997 calendar years.¹ The most popular platform grouping, Chevy S/K pickups and utilities, has production of over 1 million per year, while some of the less popular platform groupings have production of only 100,000 per year or less.

Industry's current strategy of consolidating on fewer, more flexible platforms is a response to an opposite longer-term trend. Over the past 20 years, the unit sales per platform have declined for the U.S. OEMs. In addition, more frequent model renewals are required to keep pace with faster changes in style and taste. An analysis of the OEM plans for major and minor redesigns (IRN, 1997) shows that, using the definition of platform provided in Table 2-1, an average of 12 platforms undergo major redesigns and eight undergo minor revisions in an average model year.

¹Because the definition of a platform is changing, statistics on production per platform are inconsistent over time.

Table 2-1. OEM Platforms in North American Production, 1997
 U.S. automakers currently average about two models per platform; production per platform varies widely.

OEM	Platform ^a	Nameplates	Number of Models	North American Production, 1997
Chrysler	JA/JR	Chrysler Cirrus Dodge Stratus Plymouth Breeze Sebring Convertible	4	226,977 ^b
	LH/LH41	Dodge Intrepid Eagle Vision Chrysler Concorde Chrysler LHS	5	203,988
	PL/PL41	Dodge Neon Plymouth Neon	2	205,448
	Prowler	Plymouth Prowler	1	463
	Viper	Dodge Viper/Viper GTS	1	1,790
	T-300 B-Van ^c	Dodge Ram Pickup Dodge Ram Utility Dodge Ram Van/Wagon	3	212,955
	N-Truck	Dodge Dakota Dodge Durango	2	200,174
	NS-Van/ RS-Hybrid	Dodge Caravan Chrysler Town & Country Plymouth Voyager	3	627,112
	XJ/KJ	Cherokee	1	184,888
	YJ/TJ/VJ	Wrangler	1	107,053
	ZJ/WJ	Grand Cherokee	1	278,453
	Number platforms/ models	12		24
Ford	CDW27/ CDW162	Contour Mystique	2	179,830
	MN12	Cougar Thunderbird	2	71,092
	CT20/CT120/C W170	Escort Tracer	2	277,454
	DN101/ DW186	Taurus Sable	2	495,734
	EN114	Crown Victoria Grand Marquis	2	228,616

(continued)

Table 2-1. OEM Platforms in North American Production, 1997 (continued)

OEM	Platform ^a	Nameplates	Number of Models	North American Production, 1997
Ford (continued)	FN-Series	Continental Mark VII Town Car	3	146,482
	SN95	Mustang	1	119,196
	Econoline Van	Econoline/Club	1	200,509
	Ranger	Ranger Mazda Pickup	2	367,254
	Explorer/ Mountaineer	Explorer Mountaineer	2	491,664
	PN-Truck/P131	150 Pickup 250 Pickup 250 Super Duty Pickup 350 Pickup	4	819,414
	Bronco/ Expedition/ Navigator	Bronco/Expedition Lincoln Navigator	2	268,815
	VX133/VX149	Mercury Villager Nissan Quest	2	106,783
	Windstar	Windstar	1	292,687
Number Platforms/ models	14		28	
GM	Corsa/Monza	Joy/Swing Monza	2	N/A
	EV1	EV1	1	374
	F	Camaro Firebird	2	90,393
	G	Riviera Aurora Park Avenue	3	113,577
	H	Bonneville Eighty Eight LeSabre	3	300,759
	J	Cavalier Sunbird/Sunfire	2	454,986
	K	Deville Eldorado	2	115,264

(continued)

Table 2-1. OEM Platforms in North American Production, 1997 (continued)

OEM	Platform ^a	Nameplates	Number of Models	North American Production, 1997	
GM (continued)	N/GMX130	Grand Am Achieva/Alero Skylark	3	345,980	
	P90	Malibu Cutlass	2	273,449	
	Saturn	Saturn Saturn LS	2	271,471	
	W	Chevy Lumina Chevy Monte Carlo Pontiac Grand Prix Pontiac Cutlass Supreme Olds Intrigue Buick Regal Buick Century	7	739,446	
	Y	Corvette	1	24,673	
	APV/U-Van	Lumina/Venture Trans Sport Silhouette Opel/Vauxhall Sintra	4	222,483 ^d	
	C/K Pickups C/K Utilities ^c	Pickup Sierra Tahoe Yukon/Denali Chevy Suburban GMC Suburban	6	1,125,755	
	G-Vans	Chevy Van/Express GMC Savana	2	128,285	
	M-Vans	Astro Safari	2	170,804	
	S-Pickups S-Utilities ^c	S-10 Pickup Sanoma Hombre Blazer Jimmy/Envoy Bravada	6	596,428	
	Number platforms/ models	19		50	

^aThe definition of a platform is subject to some discretion. The definitions used in the generation of these numbers may differ slightly from definitions used in other sources.

^bProduction numbers do not include Sebring Convertible.

^cCounted as two distinct platforms by some definitions and in our count of the number of platforms; however, separate production statistics were not available.

^dDoes not include opel.

Sources: IRN, Inc. December 1997. "Product Life Cycles." Grand Rapids, MI.
Automotive News. 1998a. 1998 Market Data Book. Detroit: Marketing Services Inc.

2.2 THE AUTOMOBILE DESIGN AND DEVELOPMENT PROCESS

Recent changes in the automotive design and development process have shortened cycle time and reduced engineering costs while elevating the importance of interoperability.

Automotive design and development in the U.S. have changed significantly over the last few decades. These changes have contributed to its complexity while simultaneously shortening automobile development timelines and improving product quality. Prior to these changes, U.S. automakers considered new automobile development a linear process that took 5 or more years to complete. Automakers proceeded sequentially from concept design through product design, product engineering, and component sourcing to final assembly (Womack, 1989).

U.S. automakers were compelled to rethink this linear approach to the vehicle development process in the face of stiff competition from Japanese automakers. In the 1980s, Japanese auto companies completed the automotive design process, from initial conception to delivery to consumers, in 43 months, on average; their U.S. counterparts took 63 months (Womack, 1989). Thus, Japanese automakers were able to introduce novel design changes that met customer demand more quickly and at less expense, which accounted, at least in part, for their rising market share.

Concurrent engineering, which integrates design, manufacturing, and support processes to provide early manufacturing input into the design process, is a fairly recent phenomenon in the U.S. automotive industry. The design of the GMC CK pickup in the early 1970s marked the first time in the U.S. auto industry that manufacturing engineers formally worked with design engineers. This early effort at concurrent engineering was very successful and led eventually to its further acceptance in the auto industry. By the early 1980s, Chrysler had formed its Manufacturing Feasibility Group (MFG).² The MFG worked under the philosophy that one-third to one-half of quality problems stemmed from poor design and that by integrating manufacturing and design engineering these problems could be reduced much more cheaply than they could if discovered later in the process. An important result of concurrent engineering was a reduction in the number of operations required to manufacture many parts. This translated into less equipment

²This analysis was conducted prior to the merger of Chrysler Corporation with Daimler-Benz. We refer throughout this report to market data and activities of Chrysler, rather than the combined company, Daimler Chrysler AG.

(and the required capital expenditure), fewer breakdowns, less downtime, and a shorter time to market (Dauch, 1993).

As a result of these efforts, lead times for U.S. automakers have been falling since the mid-1980s and continue to fall. Buchholz (1996) reports that Chrysler's average lead time was 54 months in 1987 and was about 29 months in 1996. The recently introduced Dodge Durango was developed in 23 months; the shorter lead time was attributable to heavy borrowing from the Dakota pickup (Brooke, 1998). The new Concorde and Intrepid redesigns took about 31 months (Jost, 1998). GM has recently reported that its cycle time has fallen from 36 months in 1995 to about 24 months today (Martin, 1998).

The current automobile development process involves concurrent design and an iterative process that requires an efficient exchange of information among processes.

The revised vehicle development process, as described by Whitney (1995) and illustrated in Figure 2-2, includes three phases: concept design, product design, and process or factory design. The development process is no longer linear; concurrent design and engineering require multiple iterations between phases and among activities within each phase.

Feedback loops, which are illustrated in Figure 2-2 by the circular arrows, require an efficient exchange of information within and between phases. Interoperability problems can interrupt this process causing delays and increasing cost.

2.2.1 Concept Design

Before designing a new product, automakers survey the market's needs. If the automakers identify a niche or need, they consider whether they can generate a suitable design at a competitive price that will meet the demands of the target market. They develop the concept by preparing computer or clay models. The styling process determines the body shape, image, and aerodynamics of the vehicle. Engineers analyze space claims and conduct interference checking in a simultaneous process called packaging to ensure that all passengers and components fit inside the vehicle's exterior. Decisionmakers also select the power train options at this stage.

Figure 2-2. The Automobile Design and Development Process
 Automobile design consists of three major phases: concept design, product design, and process or factory design. Parallel design operations occur for the automobile body and the power train.

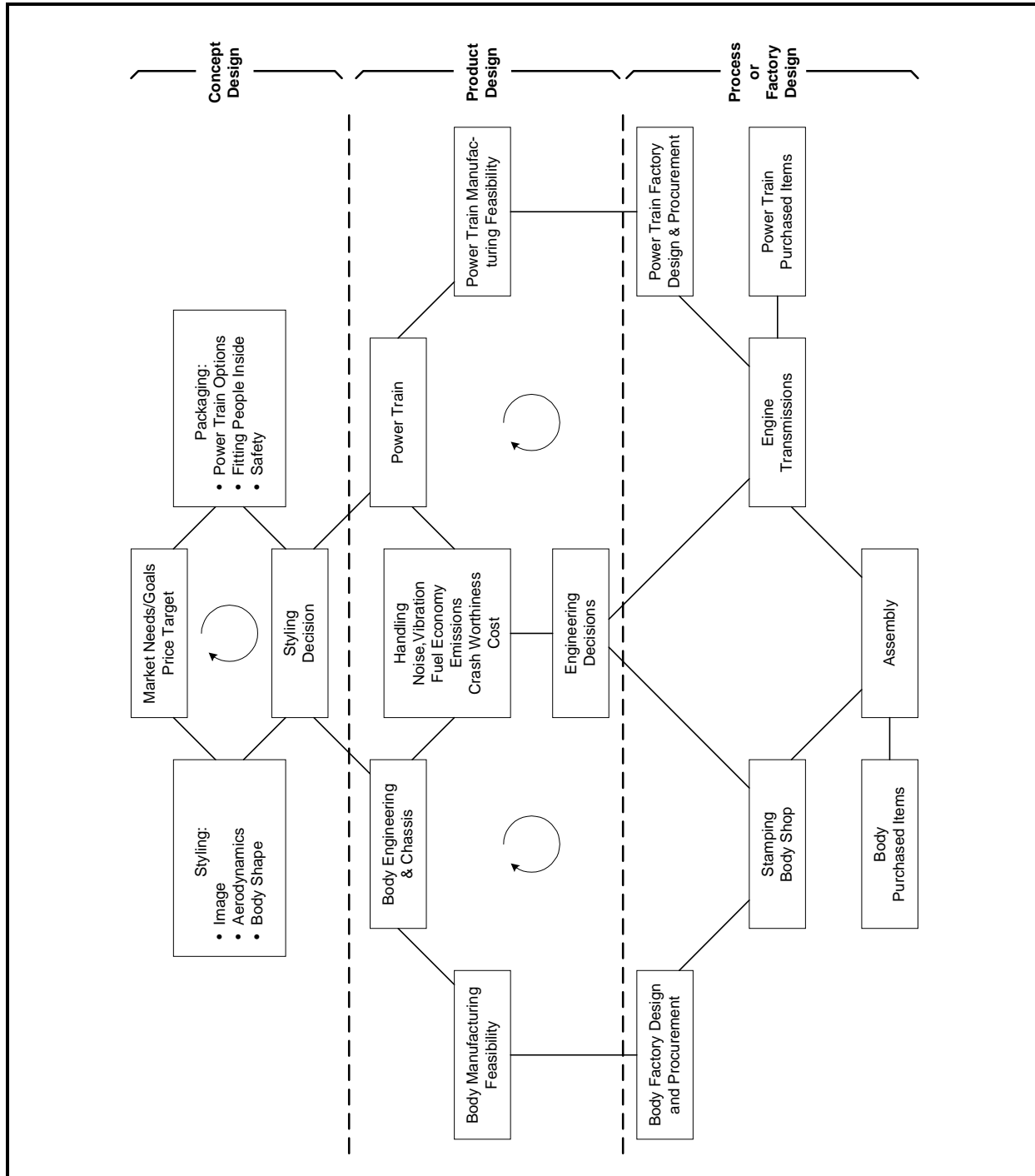

Source: Whitney, Daniel. October 1995. *State of the Art in the United States of CAD Methodologies for Product Development*. Final report under grants from Office of Naval Research and the National Science Foundation. Cambridge, MA: MIT, Center for Technology, Policy and Industrial Development.

2.2.2 Product Design

Body design and power train design proceed in concurrent timelines that meet during analysis of handling, noise, vibration, fuel economy, crash worthiness, and cost.

Once company decisionmakers have approved the concept and styling, engineers begin building and testing a prototype automobile. Engineers must develop detailed part and component specifications for the vehicle's body and its power train. Body engineers design about 20 exterior panels and 300 to 400 interior panels of various sizes. Simultaneously, power train engineers select or design the power train and determine how to arrange its components under the hood. They conduct packaging checks to ensure that there are no rival space claims and that everything fits as intended. Engineers also test the crash worthiness of the prototype and its noise-vibration-harshness (NVH) at this stage.

2.2.3 Process or Factory Design

As the product design progresses, the automaker proceeds with production procurement and design decisions for the body and power train parts. The degree of design activity conducted by suppliers varies along a continuum. At one extreme, suppliers simply manufacture parts based on the specifications and designs provided by the automaker. At the other extreme, the supplier is responsible for the component or system design, responding only to high-level specifications from the OEM. Efficient PDE is very important because data transfers are routinely made along the supply chain.

In parallel, a factory and process are designed for the parts that will be produced in-house. The plant floor layout is determined, and tooling and fixtures are designed or procured. The major segments of the factory are power train, body shop, and final assembly.

2.3 THE U.S. AUTOMOTIVE SUPPLY CHAIN

The U.S. automotive supply chain is not easy to characterize. An automobile consists of so many components that the sheer size of the industry is overwhelming. Manufacturing employment in the industry was 772,000, or about 4 percent of all manufacturing employment, in 1996. Shipments of autos and auto equipment amounted to \$329 billion in 1996, or approximately 9 percent of the value of all manufactured goods (U.S. Department of Commerce, 1998).

Characterization and analysis of the U.S. automotive supply chain are difficult because of

- ▶ the complexity of the product,
- ▶ the size of the industry,
- ▶ the complexity of the relationships between customers and suppliers, and
- ▶ continuous changes in the relationships between customers and suppliers.

Further complicating an analysis of the automotive supply chain is the complexity of the relationships between customers and suppliers. OEMs design and produce only some of the 15,000 parts and accessories that make up an automobile; they procure others from first-tier suppliers. The first-tier suppliers can in turn outsource to subtier suppliers. A company's position in the supply chain may differ depending on the part and the customer. Thus, a company that is a first-tier supplier of transmissions to one OEM may be a subtier supplier of other parts to the same or other OEMs. Furthermore, these companies, especially the subtier suppliers, often supply parts to customers outside the auto industry.

Production infrastructure, such as hardware, tooling, robots, and software, is also an important part of the supply chain (Fine and Whitney, 1996). The supply chain in the automobile market, therefore, comprises a long, dynamic, and complex network that involves the OEMs, first-tier suppliers, subtier suppliers, and companies that provide infrastructure.

Finally, the relationships among the customers and suppliers are changing over time as competitive pressures force changes on the industry. In response to Japanese competition, U.S. automakers are reducing the time it takes to develop a concept into a final product by adopting the philosophies of core competence and concurrent design. The adoption of these philosophies is forcing significant changes in the relationships between the OEMs and their suppliers (Flynn et al., 1996).

We can characterize the U.S. automotive supply chain in terms of each company's customers or in terms of its products and its role in production. In this report, we use the first method to characterize the industry.

All of these factors complicate the task of clearly identifying and describing the different components of the automotive supply chain. Analysts have proposed two competing characterizations of the supply chain. The first identifies a company's position in the supply chain based on its customers. If a company directly supplies the OEMs, it is a first-tier supplier; a subtier company supplies the first tier, and so on. However, this definition is difficult to operationalize in today's business scenario because a supplier can simultaneously serve multiple customers. As noted earlier, the same company can act as a first-tier supplier on one project and a subtier supplier on another project.

An alternative characterization identifies a company's position in the supply chain based on its products and its role in production.

The first-tier suppliers are responsible for integrating systems, while the subtier supplies modules or subsets of systems, and the next subtier contributes components and basic material (Phelan, 1997; Flynn et al., 1996).

This study focuses on the members of the U.S. automotive supply chain that are most seriously affected by imperfect interoperability—the OEMs; the first-tier suppliers, the subtier suppliers, and the tooling suppliers.

Despite the limitations of both characterizations, it is useful to choose one to facilitate a discussion of the industry's structure. We use the first method for characterizing the industry. Figure 2-3 provides a simplified view of the overall industry structure. The OEM market is highly concentrated: a few large firms dominate the market. The first-tier market is more competitive. There are hundreds of first-tier suppliers, some of which are very large with sales of billions of dollars. The subtier market is even more competitive and consists of thousands of smaller companies in addition to a few large companies. Some first-tier suppliers also operate on the subtier by either vertically integrating or by supplying parts to their rivals on the first tier. Infrastructure suppliers often supply software, hardware, tooling, and robots to all levels of the supply chain. Some of the major players at each level of the automobile supply chain are characterized below.

Figure 2-3. U.S. Automotive Supply Chain
The U.S. automotive industry is less concentrated and more competitive in downstream segments of the supply chain.

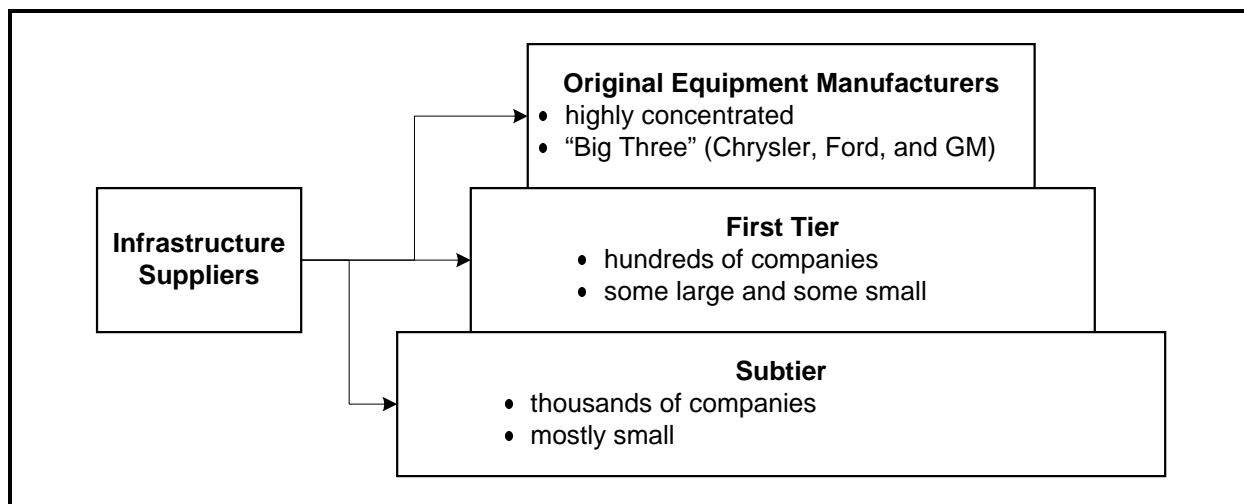

2.3.1 OEMs

The “Big Three”—Chrysler Corporation, Ford Motor Company, and General Motors Corporation (GM)—are the major U.S. auto OEMs.

As illustrated in Table 2-2, the three OEMs produced over 12 million cars and light trucks in 1997 in North America. They generated over \$378 billion in total revenue and employed over one million people in 1997.

Table 2-2. "Big Three" Production, Sales, and Employees: 1997
GM is the largest U.S. OEM in terms of production, sales, and employees.

OEM	1997 North American Production (Cars and Light Trucks)	1997 Revenue from Manufacturing (\$million)	1997 Total Revenue (\$million) ^a	1997 Number of Employees (persons)
Chrysler	2,688,054	56,986	61,147	121,000
Ford	4,395,520	122,935	153,627	363,892
GM ^b	5,454,180	153,683	178,174	608,000
Total	12,537,754	333,604	392,948	1,092,892

^aIncludes revenue from financial services, insurance, and other revenue.

^bGM statistics includes sales and employment of Delphi Automotive, which is no longer part of GM. To avoid double counting, we have not included Delphi Automotive's sales in the OEM revenue for purposes of extrapolation.

Sources: Hoover's Inc. 1998. *Hoover's Company Capsules*. Austin, TX: Hoover's Inc.

Ward's Communications. 1997. *Ward's Automotive Yearbook*. 59th Edition. Detroit: Ward's Communications.

Automotive News. 1998a. *1998 Market Data Book*. Detroit: Marketing Services Inc.

Ford Motor Co. March 18, 1998. Annual Report on Form 10K for years ended December 31, 1997. Edgar Database. <<http://www.sec.gov/Archives/edgar/data/37996/0000037996-98-000014.txt>>.

Chrysler Corp. January 23, 1998. Annual Report on Form 10K for year ended December 31, 1997. Edgar Database. <<http://www.sec.gov/Archives/edgar/data/791269/0000950124-98-000347.txt>>.

General Motors Corp. March 20, 1998. Annual Report on Form 10K for year ended December 31, 1997. Edgar Database. <<http://www.sec.gov/Archives/edgar/data/40730/0000950124-98-001456.txt>>.

In an attempt to become more globally competitive, the OEMs are restructuring to cut costs and speed vehicle development. They are increasingly focusing on parts and services in which they possess a clear competitive advantage and are outsourcing other work. GM, Ford, and Chrysler currently outsource 30, 50, and 70 percent of their vehicle content, respectively (*Auto and Auto Parts*, 1997). With GM's recent spinoff of Delphi Automotive Systems, GM's percentage of outsourced work will climb to levels more comparable to those of Ford and Chrysler. Successfully transferring the design and manufacturing of many components to their supplier base requires concurrent design processes that demand effective PDE and interaction between the OEMs and their many tiers of suppliers.

2.3.2 First-Tier Suppliers

The first tier of the supply chain consists of several hundred companies. Each supplier, depending on its size and diversity, can produce anything as minor as a part for a major system (fasteners for the brake system) or as integral as the entire axle assembly. Many of the larger companies have several divisions and sites and are responsible for producing several parts, systems, components, and accessories. Many suppliers are also increasing their input into designing and manufacturing complete modules or systems rather than just building simple component parts based on OEM specifications. Therefore, sharing data throughout the product life cycle has become an important feature of a first-tier supplier's operations.

While OEMs are becoming less vertically integrated, many first-tier suppliers are purchasing subtier suppliers to become more vertically integrated. Suppliers are becoming system integrators by combining related components into a single product to provide increased value to the OEM. Many suppliers, eager to deliver a larger share of the content of a vehicle, have become large system integrators by acquiring competitors and related-parts assemblers and operations, giving them the resources, financial strength, and the capacity to serve several manufacturers globally. For example, Lear Corporation purchased Automotive Industries in 1995 and has now acquired Masland, a maker of carpet and trim. Similarly, Johnson Controls, Inc., recently acquired interior components manufacturer Prince, and Magna International purchased Douglas and Lomason, a seat manufacturer (Flynn et al., 1996). Companies pursuing a niche in the system integration market know that they must communicate efficiently to compete effectively.

Because first-tier suppliers often work for multiple OEMs, they must purchase and maintain multiple design systems or invest in expensive translation software.

First-tier suppliers often work for multiple OEMs. For example, TRW conducts 23 percent of its business with Ford and 10 percent with GM. Johnson Controls earns 11 percent of its revenues from Chrysler and 10 percent from Ford (NIST, 1997). To varying degrees, each OEM requires its suppliers to use a specific computer-aided design/computer-aided manufacturing (CAD/CAM) design system. For example, Chrysler requires all of its first-tier suppliers to use CATIA on their work for Chrysler (AIAG, 1997a). Ford is shifting from Computervision (CV) to I-DEAS in the power train area. Body engineers at Ford currently use PDGS, which will

also eventually be supplanted by I-DEAS. GM uses Unigraphics (UG) but is less stringent about “requiring” suppliers to use UG. This is partly because GM still has some people who internally use their in-house system, CGS. Also its Saturn division uses CATIA. The use of multiple CAD/CAM systems by OEMs forces many suppliers of multiple OEMs to purchase and maintain multiple design systems or invest in expensive translation software. Furthermore, many suppliers have customers outside the auto industry that require similar CAD/CAM data. This mixed-customer base exacerbates the PDE problem by bringing even more CAD/CAM systems into the mix.

Table 2-3 lists a few of the largest members of the first tier of the automotive supply chain, their auto industry revenue, and their primary products. The total sales of the top 150 U.S. OEM parts suppliers in 1997 were over \$288.7 billion (*Automotive News*, 1998b).

2.3.3 Subtier Suppliers

Published statistics do not provide estimates of the total volume of tooling industry sales to the auto industry. However, the auto industry comprises 9 percent of the total value of manufactured goods in the U.S. (Department of Commerce, 1998). Therefore, we assumed that 9 percent of the revenue of SICs 3544 and 3599—about \$44 billion—is from the auto industry.

The subtiers of suppliers consist of thousands of smaller companies that work with OEMs only indirectly via other suppliers. An exception would be some of the first-tier suppliers that also operate on the subtier by supplying parts to their rivals on the first tier. An example is Dana Corporation, which directly supplies Ford (18 percent of its revenue) and Chrysler (11 percent of its revenue). Dana also acts as a subtier supplier to Eaton, which, in turn, supplies Ford. The subtier companies that have no direct OEM business are relatively smaller companies that supply integral components or modules to the first tier without having much interaction with the OEMs. Table 2-4 lists a few of the larger subtier suppliers and their total sales (including nonauto sales).

2.3.4 Tooling Suppliers

Production of tooling is a major element of automobile design and development in terms of both of cost and lead time. As described in Section 2.2, tooling is an important part of automobile assembly as well as the production of automobile parts. The tooling that is used to manufacture parts and assemble them must be designed in conjunction with the automobile and its component parts.

Table 2-3. Characteristics of Prominent First-Tier Suppliers
 First-tier suppliers vary in terms of their size and the range of parts and components they produce.

Company	North American OEM Auto Sales 1997 (\$millions)	Worldwide OEM Auto Sales 1997 (\$millions)	Primary Products
Delphi Automotive Systems	19,950	26,600	Brakes, steering, suspension, cockpit components, wire harness
Lear Corporation	4,672	7,300	Complete interior systems, seats
Delco Electronics ^a	4,350	5,350	Electronic systems
Johnson Controls Inc.	4,950	7,280	Seats, interior trim, batteries
Dana Corporation	4,974	6,217	Drive train, structural, engine, chassis
Magna International Inc.	3,740	5,500	Chassis, seats, and interiors
TRW Inc.	3,516	7,032	Airbags, steering, suspensions, electronic safety, convenience systems, engine components
Robert Bosch Corporation	3,300	16,500	ABS, electronic and brakes
Dupont Automotive	2,800	3,500	Engineering polymers, fibers, lubricants and finishes
Eaton Corporation	2,913	3,552	Valves, climate control, electronics
ITT Automotive	2,600	5,200	ABS, wipers, small motors, fluid handling systems, switches, die castings
Arvin Industries Inc.	1,038	1,622	Exhaust systems and ride control products
Tenneco Automotive	914	1,758	Shocks, struts, vibration control products, exhaust and emission control systems
Allied Signal Automotive	533	1,158	Turbochargers, air brakes
Cooper Automotive	360	474	Lighting and brake components, ignition and wiper products

^aSince these figures were developed, Delco Electronics was acquired by Delphi Automotive Systems.

Source: Automotive News. March 30, 1998b. "Top 150 OEM Parts Suppliers to North America." Detroit: Marketing Services Inc.

Table 2-4. Characteristics of Prominent Subtier Suppliers
 Subtier suppliers tend to be smaller and supply various parts to first-tier suppliers.

Company Name	1997 Worldwide Sales (\$millions)	Primary Products
Nypro Inc.	433	Plastic products and custom injection moldings
Ganton Technologies	78	Aluminum and magnesium die-cast parts
Lectra Systems, Inc.	175	CAM systems, CAD systems, design hardware, design software
ITW—Deltar (An Illinois Tool Works, Inc. Company)	40 ^a	Batteries and parts, door systems and trim, molded components, filtration products
Brush Research Manufacturing Co.	7.5 ^a	Engine cylinders, brake cylinders, rotors, drums, valves, and controls
Amtech Precision Products	18 ^a	Wire splices, assembly material, ignition components
Auburn Gear, Inc.	46	Axles, differentials, transfer cases, gears, and linkages
Calspan S.R.L. Corporation	110 ^a	Design hardware, engineering design, and prototyping
Cascade Die Casting Group, Inc.	65 ^a	Dies, molds, tools and equipment, filters (air, oil, fuel, pumps, tubings, hoses, and fittings)
Hamlin, Inc.	80	ABS components, airbag components, antitheft systems, sensors and actuators
HR Textron, Inc.	89	ABS components, sensors and actuators, solenoids, valves, and controls

^aEstimated by Gale Research Inc. (1997) based on prior year data.

Sources: Gale Research Inc. 1997. *Ward's Business Directory of U.S. Private and Public Companies*. Detroit: Gale Research Inc.
 Information Access Corporation. 1998. Business Index [computer file]. Foster City, CA: Information Access Corporation.
 Chilton Company. 1997. *Automotive Industries Annual Source Guide*. <<http://ai.chilton.com>>.

Imperfect interoperability between the auto OEMs, parts suppliers, and their tooling shops causes many of the same costs and delays as imperfect interoperability in other parts of the automotive supply chain. Although the tool and die industry serves many industrial customers, the automobile industry is one of its primary clients, along with the aircraft industry, the household appliances industry, and the electronic components industry. Interoperability issues in some of these other industries are very similar to those in the automobile industry.

The segments of the tooling industry that have the greatest involvement in the auto industry are SIC 3544 (Special Dies, Tools,

Jigs and Fixtures) and 3599 (Industrial Machinery n.e.c.) (Garcia, 1998). Table 2-5 provides basic statistics about the size and structure of this industry.

Table 2-5. Characteristics of the Tool and Die Industry
The tooling industry is characterized by many small, single-establishment companies.

Industry (SIC Code)	Number of Establishments, 1992	Number of Companies, 1992	Number of Establishments with Fewer than 20 Employees, 1992	Total Value of Shipments, 1996 (\$millions)	Total Number of Employees, 1996 (thousands)
3544	7,350	7,227	5,829	12,949	133.3
3599	22,756	22,591	19,400	30,751	335.3

Sources: U.S. Department of Commerce. February 1998. *1996 Annual Survey of Manufactures*. M95(AS)-1. Washington, DC: Government Printing Office.
U.S. Department of Commerce. June 1995. *1992 Census of Manufactures: Industry Series*. MC92-I-35C and MC92-I-35H. Washington, DC: Government Printing Office.

This industry is characterized by many small, single-establishment companies. The ratio of establishments to companies is only 1.01, indicating that few companies own more than one establishment.

Furthermore, most establishments are very small; 79 percent of establishments in SIC 3544 and 85 percent of establishments in SIC 3599 have fewer than 20 employees (U.S. Department of Commerce, 1995).

This industry has only recently begun using CAD/CAM systems. In 1991, ITI conducted a survey of the Detroit, mid-Michigan, and Grand Rapids Chapter of the National Tooling and Machining Association (NTMA). They found that only 59 percent of the tool and die shops they surveyed used CAM or CAD/CAM data in their work in 1991 (Fleischer, Phelps, and Ensing, 1991).

However, this situation is rapidly changing. Tool and die shops increasingly receive geometric descriptions of the end part or tooling in the form of electronic data generated on CAD systems. CAM software is then used to program the actual computer-numeric-controlled (CNC) equipment that will be used to cut the tooling (Fleischer, Phelps, and Ensing, 1991).

Tool and die shops use the design provided by their customers as a starting point and design a mold or die around the basic design.

Thus, there is still a considerable amount of design required by the tool and die shop before they can start making a mold or die (Fleischer, Phelps, and Ensing, 1991).

As tooling suppliers increase their exchange of product data with OEMs and parts suppliers, the need for improved interoperability becomes more critical. Because tooling suppliers are such a key link in the design and manufacturing process, speeding the design and manufacture of tooling and decreasing its costs can lead to important advances in the competitiveness of the U.S. auto supply chain.

3

Technical Issues in Product Data Exchange

As the volume of PDEs grows, the auto industry spends more time translating product data and solving technical problems associated with PDE. The solution of these technical problems has become an important issue throughout the industry.

The growing complexity of automobiles, the design process, and the automobile supply chain has elevated the importance of efficient product data exchange (PDE). As the volume of PDEs grows, members of the automotive supply chain spend more and more resources translating and transferring product data and solving the technical problems associated with these exchanges. These technical problems have therefore taken on greater importance, because they affect the cost and time required to design and manufacture an automobile.

This section describes the PDE process and the problems typically encountered by designers and engineers in the auto industry when they exchange product data. It also describes some potential solutions to the interoperability problem and NIST's role in developing these solutions and encouraging industry to adopt them.

3.1 INFORMATION FLOW IN THE AUTOMOTIVE SUPPLY CHAIN

Data from computer-aided design, engineering, and manufacturing software systems are routinely exchanged within companies and between original equipment manufacturers (OEMs), first-tier automotive component suppliers, subtier automotive component suppliers, and tooling suppliers. One OEM estimates that as many as 453,000 PDEs occur each year within their company and among their company and their suppliers. Another OEM estimates that

electronic exchange of computer-aided design (CAD) data alone occurs at least 7,000 times per month; that quantity rises as high as 16,000 transfers per month during peaks. This last estimate does not include transfers that take place using physical media such as tape and CD-ROM; nor does it include transfers of data besides CAD/computer-aided manufacturing (CAM) data.

Interoperability problems occur not only among different companies but among different functions within the same company.

Currently, many different computerized engineering, design and analysis, and manufacturing software and hardware systems are used throughout the automotive supply chain. Not only do these systems differ between companies but they can also differ among different functions within a company. Each system has its own proprietary data representation. As a result, product data are created and stored in multiple, frequently incompatible formats. Therefore, interoperability problems exist, whether files are being transferred between firms or within a firm.

Figure 3-1 identifies some of the different CAD/CAM platforms currently used by members of the U.S. automobile supply chain. The figure, based on AIAG (1997a), demonstrates that a first-tier supplier with several OEM customers and subtier suppliers may have to purchase, learn, and maintain multiple, often redundant platforms or translation software.

3.1.1 Data Exchange Process

Given the many different formats in which product model data are developed and stored, each data transfer requires a decision about the type of data exchange that will be used. Members of the automotive supply chain may exchange data electronically via a secure communications network, such as Automotive Network eXchange (ANX), or they may exchange physical media, such as magnetic tape, CD-ROM, or diskettes.

Regardless of what medium is used, the parties to the transfer must choose a method for transferring the data from one system to another. As illustrated in Figure 3-2, the common choices include

Figure 3-1. Multiple CAD/CAM Systems Used in the Automobile Supply Chain
Multiple translators are required to exchange data between the various players in the U.S. automotive industry.

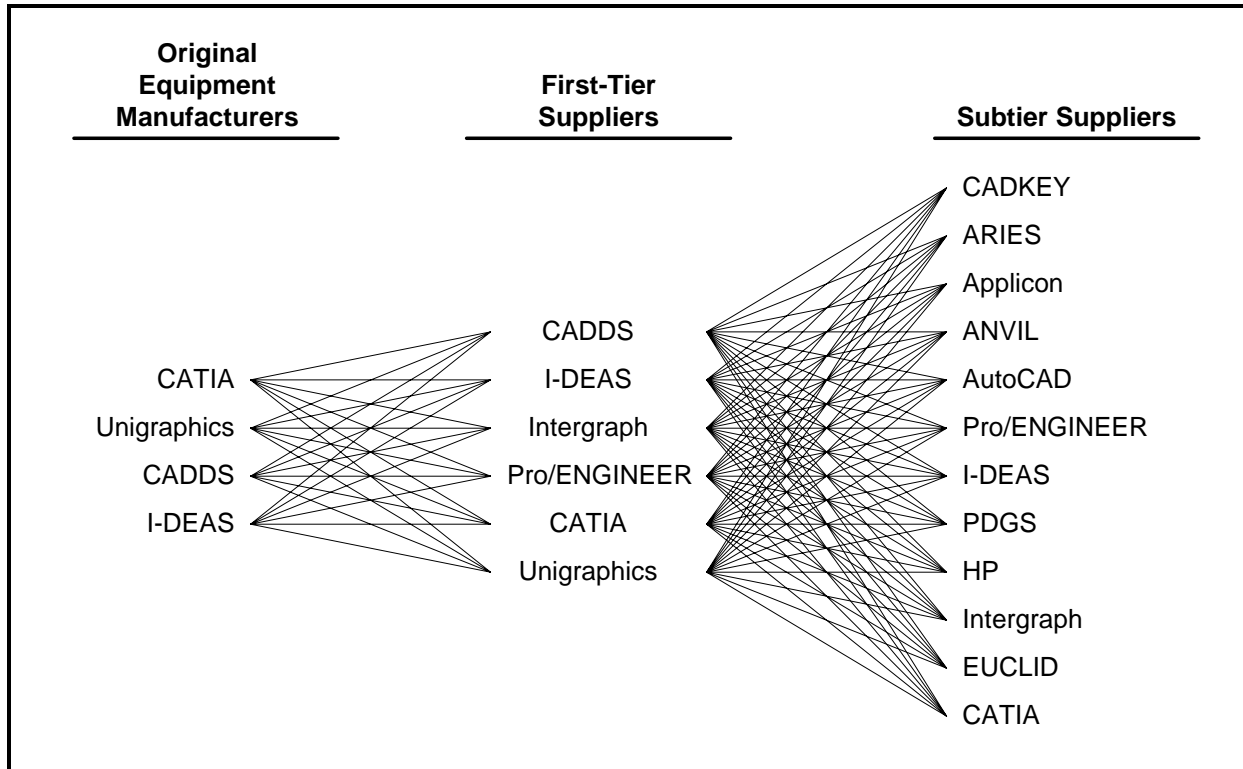

Source: AIAG. 1997a. "Product Data Exchange in the Automobile Supply Chains: AutoSTEP at the Midpoint." Southfield, MI: AIAG.

- native format transfer, in which the sender creates the data file in the same software that the receiver will use, eliminating the need for translation for that particular transfer;¹
- point-to-point translation, which uses a conversion program that transforms the data from the form used by one system to the form used by another system;
- manual reentry of product data into the receiving system; and
- neutral format translation, in which the data are translated from the originating format into a neutral format by the sender, and translated from the neutral format to the desired format by the receiver.

¹Although a translation is not required in native format transfer, it is important to note that a translation may be required before a native format transfer takes place. For example, if design data are created in Pro/E, but the customer requires the data in CATIA format, the sender must translate the data into CATIA and verify that it has been translated correctly before forwarding the native format data to the customer. Problems related to native format transfers are discussed in Section 3.2.

Figure 3-2. Generic Model of Data Exchange in the Product Development Process
 Translations between two data systems require choosing a translation method and an error correction method. Each choice has implications for the cost of the translation.

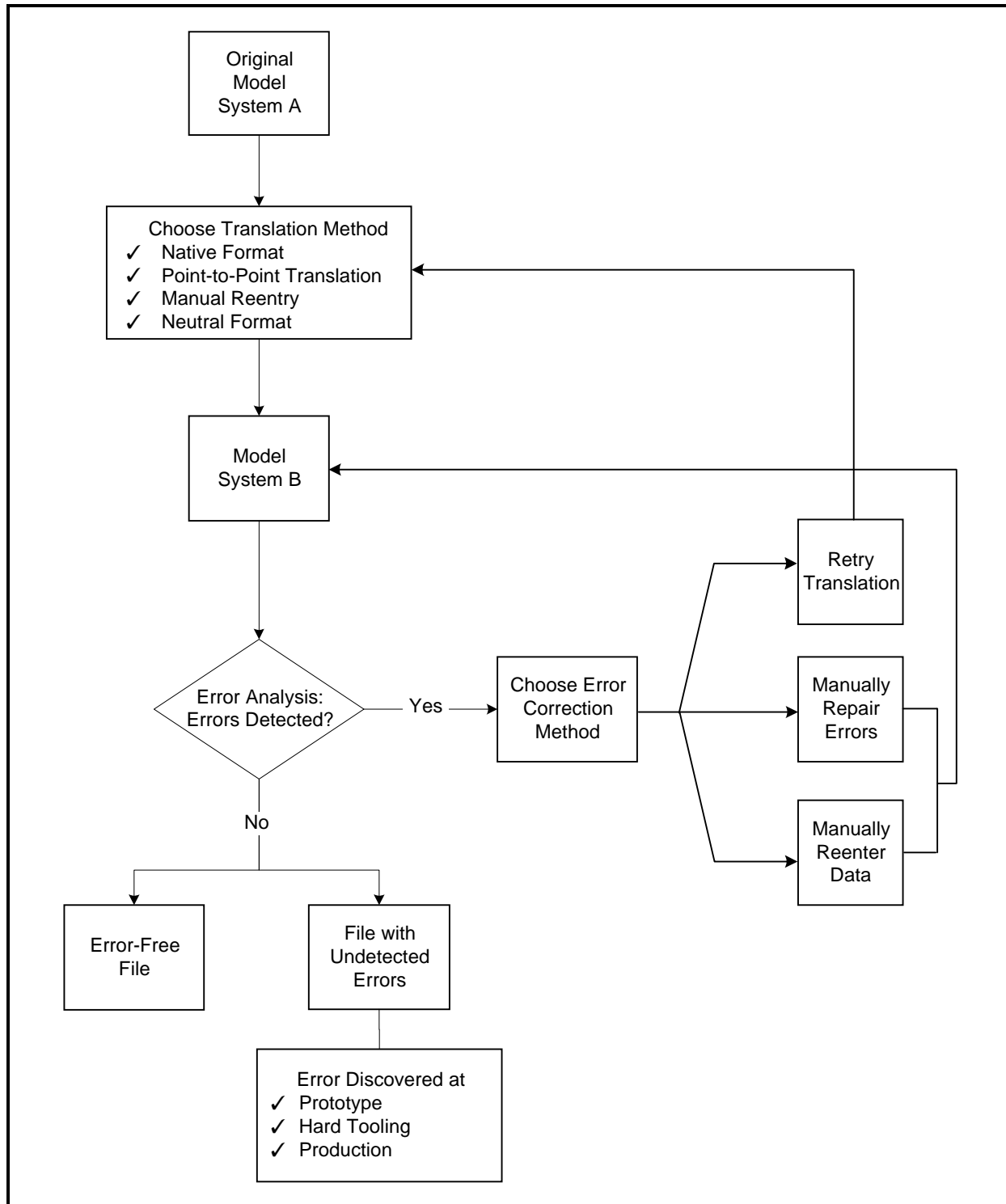

The choice among the available options depends on a number of factors, including the specific sending and receiving systems, the complexity of the data, and the availability of translators. The decision affects the direct and indirect costs associated with the exchange, because different methods for exchanging the file impose different labor and capital requirements and impose different probabilities of error and subsequent delay.

This study focuses on errors in the file that are due to both the exchange between software and hardware platforms and interoperability problems due to product data quality. Practically speaking, it is often difficult to separate problems due to hardware/software incompatibility from those due to product data quality.

After the exchange takes place, the recipient analyzes the file for errors. If no errors are detected, the exchange process is complete (however, errors may remain that are not detected and may cause problems later in the design and manufacturing process). If errors are detected, the two parties to the exchange have three choices for resolving the errors:

- reattempt the transfer, possibly using alternative settings in the translation software;
- manually repair the errors in the file; or
- manually reenter the data that need to be transferred.

File exchange errors affect costs over and above what would normally be experienced in a successful file transfer. These costs include not only the direct costs (labor and other resources) that are required to reattempt the transfer, manually repair the error, or manually reenter the data, but also the indirect costs associated with any delays related to file problems. The transfer process is repeated until the transfer has been accomplished and no errors are detected in the data file.

Theoretically, additional problems can arise from errors in the file that are undetected. As shown in Figure 3-2, these errors will most likely be detected later in the production process, either at the prototyping stage, the hard tooling stage, or the production stage. The later in the process these delays are detected, the more costly their consequences, in terms of both direct costs and indirect costs.

3.1.2 Data Exchange Problems

Problems in the exchange of product model data take a variety of forms. Some of these problems are sufficiently serious to require repeating the data exchange or recreating the model. Other problems can be repaired more easily. Some of the more common problems that require repeating the transfer of a solid model or

recreating the data include models that arrive with missing, collapsed, or inverted faces; models that do not form closed solids (surfaces and edges do not connect); and models with incorrect feature orientation (Frechette, 1997).

Other common problems associated with the transfer of CAD data include

- lines that do not meet at corners;
- lines that cross at corners;
- curves or lines drawn as many short line segments;
- multiple occurrences of the same feature at the same location;
- lines or surfaces coincident with other lines or surfaces;
- surfaces that do not meet at lines;
- some or all of the geometry not translated;
- geometry, dimensions, and notes not correctly separated into different layers;
- planar features drawn out of plane; and
- geometry of features not drawn to scale (Fleischer, Phelps, and Ensing, 1991).

Fleischer, Phelps, and Ensing (1991) surveyed members of the Detroit, Mid-Michigan, and Grand Rapids chapters of the National Tooling and Machining Association (NMTA) to determine the nature and frequency of problems incurred when tool and die shops received CAD/CAM data from their customers. The survey revealed that in about 51 percent of the jobs, the CAD data had to be repaired. The job shop had to completely recreate CAD data in an additional 25 percent of the cases. In about 15 percent of all cases, these errors were not discovered until after the part tooling had already been cut. These errors were costly and caused delays because the company had to scrap and recut the parts (Fleischer, Phelps, and Ensing, 1991).²

²At the time this study was conducted, the use of CAD/CAM data was still not a widespread practice in the tooling industry. Only 59 percent of the shops surveyed used CAM or CAD/CAM in their work, with smaller shops less likely to do so. As the industry's familiarity with CAD/CAM has increased, the incidence of these problems among shops that do use CAD/CAM seems to have declined based on our more recent interviews with tooling suppliers. However, as explained in Section 5 manual reentry and rework of product data is a significant problem.

3.1.3 Data Quality Issues

Even when data transfers are completely successful, data quality issues can lead to imperfect interoperability.

Even when data transfers are completely successful, data quality issues can lead to imperfect interoperability. A recent study by the AIAG (1997b) found that product data quality issues cause many problems for many members of the automotive supply chain. These issues exist even when product data are exchanged in native file formats. One OEM reported that downstream functions, such as rapid prototyping, finite element analysis, or CNC programming, spent a great deal of their time—as much as 50 percent—working with CAD data files that were not constructed properly for use in these downstream purposes.

These problems stem from poor model construction techniques used during CAD data entry. Examples of CAD data problems cited by the AIAG study include

- ▶ lines that do not meet at corners as intended,
- ▶ curves supposed to be tangent that are not,
- ▶ duplicate entities,
- ▶ surface patches that do not match at their joining edges, and
- ▶ solid model faces that are incorrectly formed or have improper topology (AIAG, 1997b).

These problems sometimes occur because different computational software and different operating systems develop product models with different scale and closure tolerances. Furthermore, different organizations use different conventions to organize their drawings or documents (Sawant and Nazemetz, 1998).

While translation errors of the type listed in Section 3.1.2 are usually obvious, many data quality problems are not easily detectable. The user may not realize that the data are of poor quality until a problem with a downstream software program occurs and leads to the discovery of the problem data. The farther downstream these kinds of problems are detected, the more costly they are in terms of scrapped models, model rework, and project delay.

3.2 POTENTIAL METHODS FOR IMPROVING INTEROPERABILITY

Members of the auto industry generally acknowledge that imperfect interoperability is an important and expensive problem. Yet none of the solutions that have been widely used in the past have been successful at significantly reducing these problems. This section briefly describes several approaches to improving interoperability and their technical and economic shortcomings.

3.2.1 Data Translation Methodologies

As described earlier, interoperability problems consist of both data translation problems and data quality problems. Because information is created on a variety of CAD/CAM and other engineering systems and each system has a proprietary data representation, product data are currently stored in formats that are often incompatible, so the data must be translated to transfer it from one system into another. The following methods are currently used to share data between systems, but they have a number of drawbacks:

- standardization on a single system and sharing of files in native format,
- point-to-point translation,
- manual reentry of data, and
- neutral format translation (Doty, 1994).

Single-System Standardization

Standardization on a single system may seem like the simplest way to ensure compatible data because an exchange of product data requires no translation. However, even within a single company, enforcing this standardization can be difficult because different parts of the organization have different needs and a single system may not be capable of meeting all these needs. Furthermore, even when a single system is mandated, the use of different versions of the software may create translation problems.

To minimize problems of data exchange, the three OEMs encourage or require their first-tier suppliers to maintain specific systems for the purpose of sharing product data:

- GM requires Unigraphics,
- Chrysler requires CATIA, and
- Ford requires I-DEAS.

Enforcing a single-system standard across the members of the U.S. supply chain can be even more difficult and costly. It restricts the company's collaborators to users of the same technology.

Alternatively, the company with greater market power can force potential collaborators to adopt its system of choice. The three major U.S. automobile manufacturers require their first-tier suppliers to maintain specific systems for the purpose of sharing product data. Many suppliers work with more than one major customer, each of whom requires a different system. In addition, many of these suppliers have customers outside the auto industry. This situation creates significant extra cost because, as documented in AIAG (1997a), maintaining these multiple systems concurrently causes

- less than optimal use of the systems in place, because some systems are only used a small percentage of the time (e.g., used only to transmit data to a specific customer);
- decreased proficiency of CAD users in each of the multiple systems maintained and a resulting decrease in the flexibility with which the engineering staff can be used;
- increased cost for maintaining and administering the multiple systems and increased system administration problems and system down time;
- increased training costs because CAD users must be trained on multiple systems;
- increased number of data transfers among multiple systems used concurrently for the same design project, along with the attendant accuracy problems and costs;
- increased costs of product data management (PDM), which becomes increasingly expensive because changes must be tracked through multiple design systems; and
- increased costs of maintaining quality and procedure standards for CAD data, which reduces the quality of the CAD data entering systems.

These costs may be especially burdensome to small companies that produce small volumes because some of the costs of purchasing, maintaining, and gaining expertise in these systems are fixed, rather than variable, costs. Small companies cannot spread the costs of investment in these systems across a large enough volume to make it cost-effective (Target, 1994). Thus, these requirements can function as barriers to market entry.

Point-to-point translation requires the development of $n(n-1)$ translators, where n is the number of design systems that must share data. As explained below, a neutral format facilitates data exchange with fewer translators (Frechette, 1997).

Point-to-Point Translation

A second approach to sharing data among applications is to develop and use a conversion program that transforms data from the form used by one system to the form used by another system. For some well-defined data translation tasks, these translators work fairly well. However, the drawbacks of this approach include

- the need for a pair of translators for every combination of systems that require translation (Frechette, 1997),
- the need to update each translator when either of the two systems' software is updated, and
- the lack of availability of translators for all software and all tasks.

In addition, a high degree of vendor cooperation is necessary for the development of direct translators. Sawant and Nazemetz (1998) point out that such cooperation is limited because the development of viable translators requires the disclosure of proprietary information about the software. Vendors are understandably reluctant to share such information with competitors.

Manual Reentry

When a satisfactory method of exchanging electronic data is not available, operators may manually reenter data into each system that requires it. Aside from the obvious problems of the cost and time required to manually reenter product data, it may also result in transcription errors. Nevertheless, this method is commonly used in some situations (Doty, 1994).

Neutral Format Translation

Another approach to sharing data between different systems is to develop a common neutral format for exchanging the data. Implementing the neutral format requires a pair of translators (read and write) between each application and the neutral format. Such translators are often called "half translators." With a neutral format, only two translators are required for each application, regardless of the number of other systems used to exchange data. This simplifies the maintenance of translators as each system evolves. Vendors are also more willing to develop half translators because they do not require the disclosure of proprietary code. A vendor can build a

pair of half translators for his product without interacting with his competitor (Sawant and Nazemetz, 1998).

Two alternative neutral format solutions are used most often to exchange CAD data in the auto industry: Initial Graphics Exchange Specification (IGES) and Drawing Exchange Format (DXF). These neutral format translators have shortcomings, as described below. STEP, another alternative neutral format, may be a promising solution to interoperability problems.

Alternative Neutral Format Solutions. IGES, which is a U.S. national standard, is supported by most CAD/CAM systems. DXF is a proprietary format defined by AutoDesk, the makers of AutoCAD. It is almost universally used for exchanging CAD/CAM data on personal computer-based systems (Doty, 1994). Subtier suppliers and tooling suppliers use it extensively.

Although IGES and DXF have been very successful in some limited applications, they have a number of weaknesses. IGES and DXF are limited because they were designed mainly to communicate design data, but many other types of data that support manufacturing, marketing, technical areas, cost analysis, and configuration management are required. Furthermore, IGES is used primarily in the U.S., so it cannot enable data transfers with international partners and customers. The U.S. Product Data Association (US Pro) is currently developing an IGES 6.0 release. The company has indicated that this will be the last IGES upgrade and that it will focus its development efforts on STEP (Sawant and Nazemetz, 1998).

Benefits of STEP. STEP, an alternative neutral format, is emerging as a promising solution to the interoperability problems in the automotive and other industries. STEP is a file format produced by each software package (McEwan, 1995). The International Organization for Standards (ISO) adopted STEP as ISO 10303 to achieve the benefits of such an exchange standard. Rather than translating data from one software system into another, STEP provides a complete computer-interpretable product data format. STEP allows users to integrate business and technical system data and covers all aspects of the business cycle, from design to analysis, manufacturing, sales, and service.

STEP is superior to other neutral format translators because it

- ▶ addresses many types of data,
- ▶ incorporates a superset of elements common to all systems,
- ▶ supports special application needs, and
- ▶ provides for international exchanges.

STEP goes beyond currently available neutral format translators in several ways. First, it includes more of the types of data required to develop, analyze, manufacture, document, and support many types of products. Second, rather than operating only on the elements common to two systems, STEP provides a base model that incorporates a superset of existing systems and extensions to support special application needs. Furthermore, because STEP is being developed by the ISO, it will enable U.S. companies to interact with suppliers and customers abroad.

STEP's advantages over other data translation methods are becoming clear as STEP is tested and implemented in industry. In the auto industry, a number of organizations, including the Auto Industry Action Group (AIAG), the Environmental Research Institute of Michigan's Center for Electronic Commerce (ERIM CEC),³ and NIST, have participated in a pilot project called AutoStep. The AutoSTEP pilot project is introducing STEP to the auto industry, ensuring that STEP meets the needs of the industry, and measuring the benefits from using STEP. The pilot project has tested the accuracy of models exchanged between participating members of the U.S. automotive supply chain and has produced valuable information about the potential benefits of STEP. AutoSTEP participants have transferred over 100 production part models between supply chain partners using STEP as the neutral format. Eighty-three percent of these models translated as valid solid models, and the project has been very successful at identifying and addressing translator errors (Frechette, 1997).

Fleischer (1997) points out that the AutoSTEP pilot project has been quite successful on the technical side. He notes that, after a rocky start in which the systems had difficulty translating even simple files, STEP translators have been improved to a point at which they average over 90 percent success in translation—better than most direct translation products. Frechette (1998) also notes that the CAD model exchange success of the AutoSTEP project has been improving significantly over time. The number of useable STEP-facilitated data exchanges has increased from 35 percent to 82 percent in less than 2 years.

³ERIM CEC was formerly part of the Industrial Technology Institute.

Tests have shown that STEP performs better in most cases than IGES.

Tests have shown that STEP performs better in most cases than IGES. Strub (1998a) reported on a STEP/IGES comparison study conducted by AIAG members that began in April 1997 and lasted 6 months. Sixty-one data exchanges were conducted between four major CAD systems using both STEP and IGES translators.⁴ The test criteria were file size, face count, surface count, and surface area. The test results indicated that, on average, the STEP translators conveyed 80 percent of the surface area of the original model surface, whereas the IGES translators conveyed an average of only 69 percent of the surface area. In 60 percent of the cases, STEP provided a better exchange mechanism, in 32 percent of the cases IGES performed better than STEP, and in 8 percent of the cases, STEP and IGES provided the same results (PDES, Inc., 1998).

The GM STEP Translation Center also recently conducted a study to compare the performance of IGES and STEP translators for exchanging wireframe and surface data from CATIA to UG, UG to CATIA, UG to Pro/ENGINEER, and Pro/ENGINEER to UG (PDES, Inc., 1998). The same models were transferred using both methods, as shown in Figure 3-3.

The test metrics were file size, surface count, and total surface area. The center conducted 43 tests and found that for the

- 11 exchanges from UG to CATIA, the success rate was 99 percent for STEP and 69 percent for IGES;
- nine CATIA to UG exchanges, 99 percent of the STEP exchanges were successful compared to 66 percent for IGES;
- 11 exchanges from UG to Pro/ENGINEER, both STEP and IGES were successful 99 percent of the time; and
- 12 exchanges from Pro/ENGINEER to UG, STEP and IGES were successful 98 percent of the time.

STEP's success is particularly noteworthy given the fact that IGES was implemented at least 10 years earlier than STEP, indicating STEP's potential for improving data exchange as its implementation moves forward and the commercially available STEP translators improve.

⁴The CAD systems included recent releases of CATIA, CADD5-5, Pro/ENGINEER, and UG.

Figure 3-3. General Motors' STEP/IGES Translation Process Flow for Wireframe and Surfaces
The GM STEP/IGES translation study compared the translation capabilities of IGES with those of STEP.

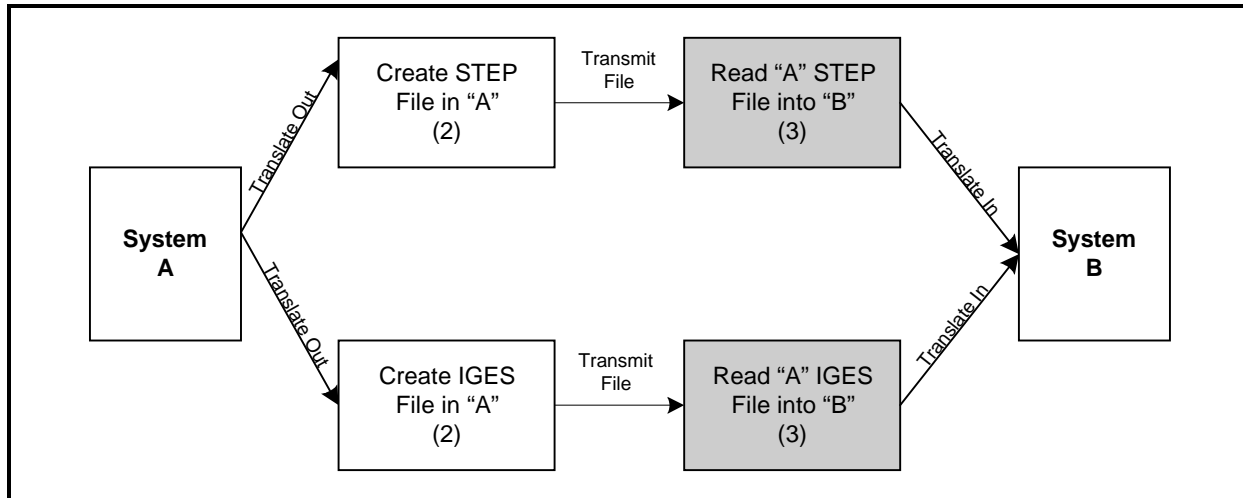

Source: PDES, Inc., 1998. Results of STEP Testing in the U.S. Auto Industry.

Demonstrations of STEP's capabilities have encouraged many members of the auto industry and other industries to begin testing STEP and using it for some data exchanges.

Such demonstrations of STEP's capabilities have encouraged the auto industry and other industries to implement this technology. Production operations at General Motor's STEP Translation Center began on May 1, 1996. STEP is now being used to transfer product design data between GM divisions. The initial focus is on translation of solid model data between UG and CATIA. GM plans to increase the scope of the project to use STEP for configuration management, data organization, and drawings (PDES, Inc., 1997c).

In November 1997, Delco Electronics announced that it had successfully replaced IGES with STEP as the PDE process in support of climate control systems for two major OEM customers. Delco uses UG design software, while two of its major OEM customers use CATIA. The original process used IGES as the neutral data format and was described as tedious and cumbersome. Delco expects the new exchange process using STEP to significantly reduce costs and cycle time compared to the old process using IGES (PDES, Inc., 1997b). In August 1997, Boeing and its engine suppliers, Pratt & Whitney, Rolls-Royce, and GE Aircraft Engines, agreed to use STEP to exchange product data in the Digital Pre-Assembly (DPA) process. The engine companies previously used custom software translators that were expensive to develop and maintain to exchange solid model data between their CAD systems and CATIA (PDES, Inc., 1997a).

STEP will certainly not solve all of the interoperability problems in the U.S. automotive supply chain. A number of issues, particularly those not directly related to translation, must be addressed in other ways. For example, in the AutoSTEP pilot project, CAD system numerical accuracy mismatch caused a number of problems with file transfers. If the receiver's CAD system has a more precise accuracy limit than the sender's system, data loss occurs during the transfer from the sender to the receiver (Frechette, 1997). Similarly, problems with translated models may be due to designer errors caused by poor or incorrect CAD data generation practices.

Even as STEP emerges as a preferred neutral format translator, native format data exchanges will nearly always be the preferred form of data exchange when available. However, for data exchanges in which native format cannot be arranged or is not cost-effective, STEP will likely become the preferred data exchange format.

3.2.2 Improving Product Data Quality

Solving product data quality issues requires creating and applying product data creation standards and procedures (AIAG, 1997b). AIAG has developed a guidebook describing best business practices for customers and suppliers who are engaged in product development. The guidebook, entitled "Best Practices in Supply Chain Product Development," was published in by AIAG August of 1998 (AIAG, 1998). It is based on a study of the best product development practices in nonautomotive supply chains that have potential automotive applications.

Implementing these practices will require an investment in training. Furthermore, high-quality product model data created following best practices take longer to create than low-quality data. Although the benefits of higher quality data can be substantial (AIAG, 1997b), they may not be recognized or realized by the company practicing good data creation practices. Instead, these benefits may accrue to the customers of these companies who must work with these data. In time, the company investing in these practices may benefit by capturing a greater market share or commanding a price premium as a result of their superior data.

3.2.3 Role of NIST

NIST has served as a catalyst in the development of standards, tools, and practices necessary to advance STEP in the auto industry.

NIST responds to industry needs for standards-based solutions to the interoperability problems being encountered among numerous engineering and manufacturing software applications in a variety of domains. NIST is helping to solve interoperability problems in discrete parts industry domains by participating in the development, implementation, and deployment of STEP. NIST has responded to requests for assistance from the auto and other industries and has acted as a catalyst in developing the standards, tools, and practices necessary to advance STEP. NIST represents U.S. interests in developing the standard and is developing a number of tools to assist industry in implementing STEP, including methods and software for testing STEP translation software. NIST has also participated in pilot programs for implementing STEP as the data exchange standard in the automotive and other industries.

Not all of NIST's relevant projects are specifically targeted to the auto industry. Many of NIST's STEP programs, such as standards development, will benefit the auto industry despite being targeted more generally to a wider group of industries. The relevant automobile-related projects under way at NIST specific to STEP are

- manufacturing standards development,
- STEP conformance and implementation testing, and
- STEP modularization infrastructural technologies.

Manufacturing Standards Development

On behalf of the American National Standards Institute (ANSI), NIST holds the secretariat for the international working groups responsible for STEP standardization (specifically ISO TC184/SC4). In this role NIST coordinates the international process for ensuring consensus among the many countries participating in STEP development. NIST also ensures that ISO guidelines for development progress are adhered to and provides an online repository of STEP information (see <http://www.nist.gov/sc4/>).

STEP Conformance and Implementation Testing

In conjunction with ERIM CEC, NIST has developed a set of value-added software tools for use by vendors and users during translator development and for interoperability trials. The tools enable vendors to test their products' conformance with the standard and

use the results of these tests to verify their conformance to potential customers. These tools can also be used during interoperability trials to verify the success of translations. NIST has placed the test systems on the Internet and currently a number of CAD/CAM software vendors who are in the process of developing and improving their STEP translators are using them.

NIST is providing software toolkits and developing metrics to support the data exchange and analysis of implementation using the STEP standard in the auto industry. These toolkits are supporting the AutoSTEP pilot program by providing network access to software, enabling users to interactively access the toolkits without the effort of installing and maintaining the software locally. NIST is also providing expertise in requirements analysis, STEP methodology, issue management, and STEP testing tools to the AutoSTEP pilot project.

AIAG is leading the implementation of the AutoSTEP pilot project with the assistance of ERIM CEC and NIST. AutoSTEP is introducing STEP to the auto industry, ensuring that it meets the needs of industry and measuring the benefits from using it. The pilot project has tested the accuracy of models exchanged between participating members of the U.S. automotive supply chain and has produced valuable information about the potential benefits of STEP (Frechette, 1997).

STEP Modularization Infrastructural Technologies

In conjunction with the international standards working groups responsible for the development of STEP, NIST is working on infrastructural technologies necessary to transition STEP development to a more modular approach. The objectives of the modular approach are to reduce the complexity of STEP specifications, promote reuse of tried-and-true STEP components, ease the ability of software vendors to support multiple STEP standards, and accelerate the standardization of STEP solutions for specific interoperability problems.

4

Estimating Interoperability Costs

The technical problems caused by imperfect interoperability impose costs on society because scarce resources are consumed to address these problems. Imperfect interoperability increases the cost of designing and producing vehicles and causes delays in the introduction of new models. These costs and delays reduce the well-being of both consumers and producers.

Building on the discussion in Section 3 of the technical issues of interoperability, this section describes the economic impact of imperfect interoperability. Section 4.1 describes a typology of interoperability costs and a set of technical and economic impact measures for quantifying these costs. It also describes the two approaches that we used to estimate total interoperability costs. Section 4.2 describes our procedures for collecting the primary data required for the analysis.

4.1 THE ECONOMIC IMPACT OF IMPERFECT INTEROPERABILITY

Imperfect interoperability reduces society's economic welfare by

- ▶ increasing the cost of designing and developing automobiles and
- ▶ delaying the development of new automobiles.

Interoperability problems in the automobile industry affect society's economic welfare in two ways: by increasing the cost of designing and producing automobiles and by delaying the introduction of improved automobiles. An increase in the cost of designing and producing a new vehicle may lead to an increase in the equilibrium price of automobiles and/or a reduction in the quantity of automobiles exchanged in the market. Depending on the structure of the market, the lost social surplus will be shared by

consumers, who will pay higher prices, and producers, who will earn lower profits.

A delay in the introduction of an improved automobile also imposes costs on consumers and producers. The late introduction of a new product or service can lead to a loss in consumer surplus because consumers cannot benefit from the product's improvements until it becomes available. For example, Hausman (1997) found that consumer welfare declined significantly when federal and state regulations delayed the introduction of new telecommunications services. In the context of this study, the delay of the introduction of a new vehicle may force a consumer to purchase a vehicle that does not provide as much net value (value minus price). This loss in consumer surplus can be attributed to the late arrival of the preferred vehicle.

Producers can also lose market share and revenues if a new vehicle is delayed. However, producers can incur significant losses even if market share and revenues are not lost, but simply put off, due to discounting. Clark, Chew, and Fujimoto (1987) estimated that the discounted present value of the profits from the introduction of a new vehicle could fall by as much as one million dollars for each day of delay of the product introduction. Martin (1998) verified this estimate via interviews with industry officials.

Delays in the production of intermediate products (parts and assemblies) can also increase the cost of design and production. They may cause bottlenecks in the automobile design and manufacturing process, leading to the inefficient use of capital and labor.

4.1.1 Cost Drivers and Cost Categories

A number of factors affect the resources required to successfully share product data among members of the U.S. automotive supply chain. Table 4-1 describes these cost drivers. Although this list may not be comprehensive, it describes the primary factors that affect the level of interoperability costs, determined from informal and formal interviews with members of the U.S. automotive supply chain. This list provided a launching point for developing a taxonomy of interoperability costs.

Table 4-1. Interoperability Cost Drivers

Several factors affect the resources required to conduct product data exchange (PDE) and the implication of delays caused by interoperability problems.

Cost Driver	Description
Number of customers/suppliers	▶ Additional customers and/or suppliers may increase the required number of computer-aided design (CAD) systems or translators.
Position in supply chain	▶ Original equipment manufacturers (OEMs) require that their suppliers provide PDE data in the native format of the OEMs' choosing; subtier suppliers are often too small to maintain multiple platforms or translators. Therefore, first-tier suppliers often incur the costs of the interoperability problem (but may pass these costs on to the OEMs).
Design responsibility	▶ Does the supplier provide significant design input, or do they simply manufacture the part to the customer's design specifications? Joint design responsibility requires the greatest level of data exchange between the supplier and the customer.
Design reuse	▶ Is the component design new or is it a modification of an existing design? New designs require a greater level of data exchange.
Design complexity	▶ The more complex the design, the greater the probability that errors will occur during file transfer. File size is often used as a proxy for design complexity.
Tolerance	▶ The smaller the permissible margin of error or required goodness of fit, the more imperative it is to repeat transfer attempts or manually reenter data so that the file is error free.
Number of prototype iterations	▶ Increasing the number of prototype iterations increases the cost of PDE.
Life-cycle impact	▶ Late changes in design or error detection increase costs.
Degree of concurrent design and engineering	▶ The greater the number of systems that are being designed and manufactured concurrently, the greater the probability that delays in developing a given component/system will delay other components/systems.
Engineer training and use of design standards	▶ When engineers are trained and make use of standard practices for the development of CAD data, the data are more usable by downstream functions.

The automotive supply chain incurs several types of costs related to imperfect interoperability. Automakers incur *avoidance costs* to prevent technical interoperability problems before they occur. *Mitigating costs* consist of the resources required to address interoperability problems after they have occurred. *Delay costs* arise from interoperability problems that delay the introduction of a new vehicle.

Imperfect interoperability generates

- avoidance costs,
- mitigating costs, and
- delay costs.

Avoidance costs include

- the cost of purchasing, maintaining, and training for redundant CAD/computer-aided manufacturing (CAM) systems for the purpose of native format translation;
- the cost of purchasing, maintaining, and training for point-to-point translation software;
- the cost of purchasing, maintaining, and training for neutral format translation software;
- outsourcing costs incurred when outside companies are hired to provide data exchange services;
- investments in in-house programs aimed at addressing interoperability issues, such as implementing STEP or training engineers in proper product model data creation; and
- the cost of participating in industry consortia activities aimed at improving interoperability throughout the industry.

Mitigating costs include

- the cost of reworking scrapped models, designs, prototypes, parts, dies, etc., that were incorrect due to interoperability problems; and
- the cost of manually reentering data when other methods of data exchange are unavailable or unsatisfactory.

Delay costs include

- profits lost due to decline in market share caused by delays;
- profits lost due to delay of revenues (discounts the value of future profits); and
- losses of consumer welfare due to delay of the availability of products with greater net value.

Our analysis includes each of these kinds of costs except for the losses to consumers.

4.1.2 Impact Measures

Quantifying the costs described above requires appropriate metrics that capture the most important impacts. We developed two kinds of impact metrics:

- *Technical impacts* describe the effects of imperfect interoperability on the accuracy and usability of exchanged product data and the resources required (including time) for data exchange and product development.

- *Economic impacts* describe how technical impacts translate into changes in cost and economic activity. These measures can be either quantitative or qualitative.

The sources of costs and the technical and economic metrics that we used to measure interoperability costs are summarized in Table 4-2. These metrics can be linked to the cost drivers presented in Table 4-1. For example, the greater the number of customers/suppliers a company works with, the greater the number of CAD/CAM systems and translators it must purchase and maintain and hence the greater its avoidance costs. The more complex, and/or the newer the design of a given component, the greater the probability of errors occurring during PDE, increasing mitigating costs. This increases the number of attempts required to successfully transfer the data.

4.1.3 Quantifying Costs

We estimated interoperability costs using two approaches:

- cost component approach
- aggregate cost approach

We employed two separate approaches to quantifying the economic metrics described in Table 4-2. Our first approach was to collect primary and secondary data on the level of costs related to each of the technical and economic metrics shown in Table 4-2. By summing these components of cost, we developed an estimate of the total interoperability costs in the industry. We refer to this approach as the cost component approach.

Our second approach was to interview key industry executives about interoperability cost issues and to ask them to consider the scope of all interoperability problems in their company. We asked them to provide an estimate of the total cost of all components of interoperability costs. We refer to this approach as the aggregate cost approach.

Each of these approaches has merit. The cost component approach builds a cost estimate from information provided by industry and other sources. Interviewees provide only pieces of the total estimate. It puts less burden on industry officials to process all of the information to provide an overall estimate.

However, the aggregate cost approach allows industry officials to consider interoperability cost factors that we may not have considered. It allows them to consider the entire scope of the problem and offer a vision of the automobile industry with perfect

Table 4-2. Metrics for Interoperability Costs
 We measured interoperability costs from several different sources.

Source of Cost	Components	Technical Metric	Economic Metric
<i>Avoidance Costs</i>			
Multiple CAD/CAM systems	CAD/CAM software licenses	Number of CAD/CAM software licenses required by type	Investment in CAD/CAM software licenses
	System maintenance	Labor required to maintain all CAD/CAM systems	Cost of labor required to maintain CAD/CAM systems
	System training	Labor hours devoted to training and gaining competence on all CAD/CAM systems	Cost of labor time required to gain competence on all CAD/CAM systems
Multiple translators	Translation software licenses	Number of translation software licenses required by type	Investment in translation software licenses
	Software training	Labor hours devoted to training on the use of different translators	Cost of training labor to use different translators
Outsourcing data translation	Third-party suppliers	Jobs outsourced to third-party suppliers of data exchange services	Cost of outsourced work
Investments in interoperability solutions	In-house interoperability research	Capital, labor, and materials devoted to in-house interoperability research	Cost of in-house interoperability research
	Activities in industry consortia	Time and materials devoted to participation in industry consortia	Cost of membership, labor time, and materials devoted to consortia activities
<i>Mitigating Costs</i>			
Poor quality CAD/CAM files	Scrapped models, designs, prototypes, parts, dies, etc.	Hours required to rework models, designs, prototypes, etc.	Cost of time required to rework scrapped data, parts, etc.
	Manual data reentry	Number of jobs that required reentry and labor cost per reentry job	Total cost of manual data reentry

(continued)

Table 4-2. Metrics for Interoperability Costs (continued)
 We measured interoperability costs from several different sources.

Source of Cost	Components	Technical Metric	Economic Metric
<i>Delay Costs</i>			
Delays	Car sales forfeited	Length of delay and the number of car sales forfeited per period of delay	Length of delay times the profits lost per period of delay
	Delayed profits	Length of delay and the number of cars that would have been sold per period of delay	Value of profits with no delay—value of profits discounted over period of delay

interoperability among computer systems and software. This approach may provide a more accurate estimate because its scope may be more complete.

By using both of these methods, we are able to provide not only an estimate of the overall costs of interoperability, but also information about the relative importance of these sources of costs. Using both methods also provides an opportunity to check the estimates against each other. As Section 5 indicates, our estimates of the total interoperability costs in the U.S. automotive supply chain do not differ significantly between these two methods.

4.2 DATA COLLECTION PROCEDURES

To construct the two types of cost estimates described above, we developed and executed the data collection procedures described in this section. The data collection plan included three steps:

- develop a sampling plan,
- draft and revise survey instruments, and
- conduct surveys.

4.2.1 Sampling Plan

Our sampling plan focused on three key components:

- choosing the appropriate auto industry segments to survey,
- formulating a purposive sampling strategy, and
- developing a data extrapolation methodology.

Industry Segments

The U.S. auto supply chain comprises a long and complex network that involves three major OEMs, hundreds of first-tier suppliers, thousands of subtier suppliers, and many providers of tooling and other infrastructure. Resource constraints made it impossible for us to survey each company in each tier of the supply chain. Another complicating factor was the difficulty of defining each supplier's position in the supply chain, as described in Section 2. Therefore, our sampling frame classified suppliers on the basis of their size, rather than their position in the supply chain. We note, however, that most companies normally considered part of the first tier are larger than companies normally considered part of the subtier.

Given these constraints, one of the key study design decisions for this task was to determine the industry segments to survey. We based this decision on two important considerations:

- the degree to which an industry segment has been affected by data exchange problems; and
- the resources required to identify the requisite data, contact the data source, and collect the data from each industry segment.

This study focuses on the interoperability costs of OEMs, large suppliers, and tooling suppliers.

Based on these considerations, we limited our data collection efforts to the OEMs, the large suppliers, and the tooling suppliers. OEMs stand to lose market share if interoperability problems cause delays in bringing new platforms to market. Larger suppliers serve multiple customers and are often intimately involved in the design process; thus, interoperability problems are also likely to be a significant issue for them. Tooling suppliers are increasingly exchanging product data with parts suppliers and OEMs, and PDE issues are becoming more and more important to this segment of the automobile supply chain. However, very small suppliers often are not involved in the design process; hence, their interoperability costs are expected to be lower. Because we did not survey other industry segments such as subtier suppliers and suppliers of infrastructure other than tooling, our quantitative estimates provide a conservative estimate of the total interoperability costs faced by the U.S. automobile industry.

Sampling Strategy

Our sampling strategy was to interview all three OEMs and a purposive sample of suppliers and tooling manufacturers. A purposive sample allowed us to select a sample based on stratification variables as well as factors that minimize the difficulty of obtaining the data, such as the availability of key informants at each company. Although a purposive sample has drawbacks (e.g., we cannot make statistical statements about the precision of estimates with respect to the population), we decided it was the best strategy given the time and resource constraints of this project.

We used the list of top 150 suppliers created by *Automotive News* (1998b) as our sampling frame for the supplier segment of the industry. For tooling suppliers, we began with the list of tooling suppliers that participated in an earlier study of the use of product data in the tooling industry (see Fleischer, Phelps, and Ensing, 1991). In some cases, these suppliers provided contacts at other companies that provided additional data.

Extrapolation Methodology

Because we surveyed a small purposive sample of the industry, we cannot claim that the survey results are statistically representative of the entire affected population. Nevertheless, we developed methods for extrapolation based on sales information available from secondary data sources. Although this extrapolation procedure does not provide estimates with definable statistical precision, it does provide a cost-effective, reasonable, and defensible method for developing an industry estimate. We provide details about the extrapolation procedure in Section 5.

4.2.2 Survey Instruments

We designed survey instruments that could be used either as a telephone interview guide or as a written survey the respondent could complete and send to us. We developed a different survey instrument for each of the relevant industry segments: OEMs, suppliers, and tooling suppliers. The survey instruments asked for the information needed to estimate interoperability costs using both the cost component method and the aggregate cost method. We reviewed the survey with industry consultants and NIST, and these early reviews led to several revisions of the survey.

4.2.3 Survey Implementation

We collected some of the primary data via the telephone interviews; other data were collected via written survey responses. We allowed each respondent to choose the response method with which he/she was most comfortable. Many respondents provided both written and oral responses.

The interview team

- identified the candidate person for the interview;
- called the selected individual, described the study, and requested his/her participation;
- sent the selected individuals our survey instrument and other information about the study;
- conducted the interview over the phone or solicited written answers, depending on the preferences of the respondent; and
- followed up with the respondent to clarify written responses.

Locating the appropriate contact within each company was one of the most important data collection challenges. We asked our consultant, industry contacts, and NIST staff for referrals to the appropriate person whenever possible. Where we had no referral, we directly contacted selected organizations to identify the person most likely to have the knowledge and clearance to answer our questions.

5 Cost Estimates

Our analysis indicates that imperfect interoperability imposes about \$1 billion of costs each year on the members of the U.S. automotive supply chain. By far, the greatest component of these costs is the resources devoted to repairing or reentering data files that are not usable for downstream applications.

We consider this estimate of interoperability costs of the U.S. automotive supply chain to be conservative. As explained in this section, the project's scope, time and resource constraints, and data limitations hampered our efforts to quantify several sources of interoperability costs, including:

- ▶ post-manufacturing interoperability costs,
- ▶ interoperability costs of small suppliers,
- ▶ in-house investments in interoperability solutions,
- ▶ costs to consumers from delays in new product introduction, and
- ▶ lost profits from declining market share caused by delays.

In this section, we describe how we developed these estimates and discuss the estimates in the context of qualitative information about the sources of these costs. As described in Section 4, we used two methods to develop these estimates: the cost component approach and the aggregate cost approach. While these two methods lead to roughly the same estimate of the costs of imperfect interoperability, they both exclude some possibly significant costs that we were not able to quantify. Section 5.1 describes the methods and results of the cost component approach, while Section 5.2 provides the estimates from the aggregate cost approach. Section 5.3 discusses

the differences between these estimates and the costs that we were not able to quantify.

Our results are based on interviews with representatives of ten companies: two of the “Big Three” auto original equipment manufacturers (OEMs), five suppliers, and three tooling companies. To add qualitative information from a slightly different perspective, we also discussed interoperability issues with one company that manufactures auto-related equipment. The combined 1997 sales of the five suppliers we talked with was over \$38.4 billion. This represents about 13 percent of the sales of the “large supplier segment” of the auto industry.¹ The three tooling companies we interviewed together comprise about \$79 million in sales, most of which is conducted in the auto industry. Although the tooling industry is difficult to define, we estimate that these three companies comprise about 2 percent of the total tooling business in the auto industry.²

5.1 INTEROPERABILITY COST ESTIMATES: THE COST COMPONENT APPROACH

Industry estimates of interoperability costs are extrapolated from survey responses using a weighting factor based on the percentage of industry revenue the sample represents.

We collected information about avoidance costs, mitigating costs, and delay costs from members of each of three segments of the U.S. automotive supply chain: OEMs, suppliers, and tooling suppliers. For each industry segment, we developed industry estimates by summing the costs provided by the respondents and multiplying those costs by a weighting factor based on the percentage of revenue the sample represented. For example, the total revenues of the tooling suppliers responding to the survey represented about

¹We used an *Automotive News* (1998b) list of the top 150 OEM suppliers as a sample frame to define the “large supplier segment” of the auto industry. Their combined sales in 1997 were estimated to be over \$288.7 billion. We limited the extrapolation of our survey results to this segment only.

²As explained in Section 2, two Standard Industrial Classification (SIC) codes comprise most of the tooling suppliers that work for the automotive industry: 3544 and 3599. However, these SIC codes include suppliers of tooling to many other industries as well. The auto industry comprises 9 percent by value of shipments of all manufacturing (U.S. Department of Commerce, 1995). Therefore, we assumed that 9 percent of the value of tooling business in these industries was supplied to the automobile industry.

2 percent of total industry revenue; thus, we multiplied their summed responses by a factor of 50.³

Table 5-1 presents a summary of the results of our analysis using the cost component approach. The estimated annual costs total about \$1.05 billion per year. The majority of the annual costs are attributable to mitigating costs—the cost of correcting problems caused by imperfect interoperability.

Table 5-1. Summary of Annual Interoperability Costs: Cost Component Approach
Mitigating costs represent the largest share of interoperability costs in the U.S. automotive supply chain.

Source of Cost	Costs by Industry Segment (\$thousands)			Total	Percent of Total
	OEMs	Suppliers	Tooling		
Avoidance costs	2,302	35,656	14,841	52,799	5
Mitigating costs	247,773	204,094	455,778	907,645	86
Delay costs				90,000 ^a	9
Total costs				1,050,444	100

^aWe could not determine the distribution of delay costs or total costs.

5.1.1 Avoidance Costs

Industry incurs avoidance costs to prevent technical interoperability problems before they occur. As shown in Table 5-1, the automotive supply chain spends about \$53 million per year on avoidance costs; these costs represent about 5 percent of total interoperability costs. Most of these costs are borne by the suppliers.

As described in Section 4 and shown in Table 5-2, avoidance costs include the costs of

³There was some variation in the extrapolation factors among the different cost components. For example, on some questions, the suppliers in our sample responded with respect to their entire company. In these cases, the extrapolation factor was 7.5, because these companies represented about 13 percent of total industry sales. In other cases, they could respond only for their division. In this case, the extrapolation factor was about 50, because their division together accounted for only about 2 percent of total industry sales.

- purchasing, maintaining, and training for redundant computer-aided design (CAD)/computer-aided manufacturing (CAM) systems for the purpose of native format translation; point-to-point translation software, and neutral format translation software;
- outsourcing incurred when outside companies are hired to provide data exchange services;
- investments in in-house programs aimed at addressing interoperability issues, such as implementing STEP or training engineers in proper product model data creation; and
- participating in industry consortia activities aimed at improving interoperability throughout the industry.

The first component listed in Table 5-2, redundant software, costs the industry over \$30 million per year, split roughly equally between suppliers of automotive parts and assemblies and suppliers of tooling. Although the cost of purchasing the licenses required to run this redundant software is an important part of these costs, the cost of training engineers to work on these systems is slightly larger. Outsourcing of data translation is also a significant part of the avoidance cost, while investments in interoperability solutions cost the industry roughly \$4 million per year. Below, we provide greater detail about the sources of these costs.

Table 5-2. Sources of Annual Avoidance Costs
The cost of maintaining redundant software is the largest share of avoidance costs.

Source of Cost	Costs by Industry Segment (\$thousands)			
	OEMs	Suppliers	Tooling	Total
Redundant software				
Licenses	0	8,918	3,107	12,025
Maintenance	0	4,524	2,821	7,345
Training	0	3,278	8,914	12,192
Redundant software costs (subtotal)	0	16,720	14,842	31,562
Data translation outsourcing	2,042	15,594	0	17,636
Investments in interoperability solutions	260	3,341	0	3,601
Total avoidance costs	2,302	35,655	14,842	52,799

Redundant Software

Suppliers and larger tooling companies maintain some CAD/CAM systems, point-to-point translation software, and neutral format software primarily to satisfy the data exchange needs of their projects. Some larger suppliers have several redundant systems because they supply several OEMs. In addition, all the suppliers use at least one neutral format software (IGES, DXF, or STEP) and many also use point-to-point translation software. The survey respondents listed the software they considered redundant.

We annualized the one-time purchase price of redundant software over the expected duration of its useful life.⁴ While the software might be purchased in a specific year, it will probably be used for a number of years. In this regard, the cost of purchasing these systems is similar to any other capital investment.

In addition to the one-time purchase cost, many software licenses require an annual system maintenance cost (e.g., cost of receiving updates and servicing the license). In addition, companies must train their personnel on these software, adding additional costs to maintaining these multiple redundant software packages. The annual cost of training was actually slightly larger than the annualized one-time cost of purchasing the licenses.

Data Translation Outsourcing

Some firms outsource their PDE to third parties, while others have internal departments that operate in this capacity for their internal clients. We included both types of “outsourcing” in this cost category, which we estimate at \$18 million per year.

Our definition of outsourcing costs includes the cost of maintaining internal departments that operate as data translation service providers for their company.

Among the five suppliers, we interviewed four companies reported that they used third-party solutions for their PDE needs in 1997. One company reported that outsourcing their PDE allowed them to eliminate some of the redundant CAD/CAM systems. None of the tooling companies nor the OEMs reported using third-party translation services. However, OEMs and some suppliers have in-house departments dedicated to performing PDE operations for the

⁴To annualize the one-time purchase costs of software, we assumed a 7 percent discount rate as recommended by OMB (1995), and a useful life of 5 years for the software is recommended by several industry contacts.

company or division. These costs are included in the outsourcing category.

While third-party solutions do not appear to be extensively used in the auto industry at the present time, their significance as an interoperability solution could increase in the future as more qualified data translation services become available. If the OEMs continue to require that suppliers deliver files in native format, and as suppliers diversify the number of customers they serve, outsourcing may become a more cost-effective option because the suppliers can reduce the number of redundant CAD/CAM systems they maintain.

However, OEM representatives expressed concern about this trend. The respondents indicated the following concerns:

- The supplier and the OEM are less likely to recognize loss of data if translations are executed by third parties.
- Vendors can charge very high rates.
- Vendors can delay a project.
- Vendors can be unreliable and the quality of their translations are sometimes poor.
- Vendors often do not understand the product very well and therefore are unable to make appropriate adjustments to solve translation problems.

These factors can lead to complications and can affect the quality, cost, and timing of the project.

Investments in Interoperability Solutions

The OEMs and most of the large suppliers participate in industry efforts to solve problems associated with imperfect interoperability. The costs of these efforts, including membership fees, labor time devoted to consortia activities, and travel expenses, total about \$3.6 million per year.

In addition, the OEMs conduct their own research and development toward the solution of interoperability problems. For example, the GM Step Translator Center was started in 1995 at GM to evaluate STEP implementations of interest to GM. Some of the studies conducted by the GM STEP Translator Center are discussed in Section 3.

While the cost of these programs clearly falls into this category of avoidance costs, we were not able to obtain an estimate of the budget of the GM Step Translator Center. And we could not obtain an estimate of other kinds of internal research activities by the other OEMs. Thus, our estimate of mitigating cost does not include the cost of these internal activities by the OEMs.

5.1.2 Mitigating Costs

The OEMs together spend approximately \$248 million per year correcting or recreating unusable data.

By far, the largest portion of interoperability costs is due to the need to repair or replace unusable data files. The OEMs together spend approximately \$248 million per year correcting or recreating unusable data. One OEM mentioned that downstream engineering departments spend as much as 50 percent of their time dealing with poor translations or poor quality CAD/CAM data files. Another OEM noted that, on the average, rework requires an average of 4.9 hours per data exchange. With over 450,000 PDEs per year, this rework is extremely expensive in terms of engineering labor time.⁵

Suppliers and tooling companies also incur significant mitigating costs. Suppliers incur over \$204 million per year for reworking data files. All but one supplier we talked with reported labor costs caused by incomplete or incorrect data files that had to be reworked or reentered manually. The need to manually reenter data is especially troublesome for the tooling companies. They report that a large proportion of their jobs require rework or reentry of some kind. These costs amount to over \$455 million for all tooling suppliers—significantly higher than the costs reported by the suppliers.

Tooling suppliers incur significant costs for reentering and reworking data because the product data they receive from their customers usually do not meet the needs of tooling design.

Our interviews with the tooling suppliers indicate two reasons for these high costs. First, tooling suppliers typically have one primary CAD system into which they must transfer all incoming data (although some large tooling suppliers do maintain a seat on the customer's system to receive the data in the first place). The second reason, which is probably more significant, is that tooling suppliers must make significant changes to the product data to make it useful for their purposes. That is, the data as delivered do

⁵We assumed a loaded wage rate of \$59.20, which we based on a \$25.00 per hour wage rate for a Level III Engineer (DOL, 1996a), a 48 percent benefits rate (DOL 1996b), and a 60 percent indirect cost rate.

not meet the needs of the tooling design, so they have to rework it to make it useful.

5.1.3 Delay Costs

As described in Section 4, we collected information about two types of delay costs:

- the lost profits due to a decline in market share and
- the decline in the net present value (NPV) of the lost profits due to delay of revenues.

We asked the OEMs and the suppliers to estimate the amount by which development time for their products would fall if interoperability problems did not exist.⁶ Although the answers differed among the respondents, the average for the suppliers weighted by their revenue shares was about 4 months (from an average 36-month development time), and the OEMs estimated a reduced development time of about 2 months. Using the more conservative estimate provided by the OEMs, we assumed that without interoperability problems, new automobile models would be available 2 months earlier if no interoperability problems occurred.

Most respondents indicated that they experienced no significant potential loss in market share due to delays caused by interoperability costs, or they were not able to quantify this impact. However, because of discounting, producers may incur significant losses even if market share and revenues are not lost, but simply put off. Clark, Chew, and Fujimoto (1987) estimated that the discounted present value of the profits from the introduction of a new vehicle could fall by as much as \$1 million for each day of delay of the product introduction.⁷ Martin (1998) verified this estimate via interviews with industry officials, and we used this estimate to determine the average per-day cost of a delay in product introduction.

⁶The exact wording of the question was, "If your company/division experienced NO data exchange problems between any of your engineering systems or with any of your suppliers or customers, by how much time do you think the design and manufacturing lead time would shorten?"

⁷Clark, Chew, and Fujimoto used the following assumptions: 1) A very successful vehicle may generate gross revenues of \$7.5 billion over its life: 5 years at 200,000 units a year at a wholesale price of \$7,500. 2) A 10 percent discount rate. 3) With labor and capital in place at the planned launch date, lost profits could be as high as 60 percent of lost revenue.

On average, the three OEMs introduce about one and one-half new models per year (12 new models in 8 years [IRN, 1997]). A 2-month delay in the introduction of these vehicles, at a cost of \$1 million per day implies a \$90 million annual cost for the delay of the introduction of these vehicles because of imperfect interoperability. We were not able to assign these costs by sector.

5.2 INTEROPERABILITY COST ESTIMATES: THE AGGREGATE COST APPROACH

We employed the aggregate cost approach to corroborate the estimates from the cost component approach.

We employed a second method to estimate interoperability costs to corroborate the results of our component cost analysis. Our second approach was to interview key industry executives about interoperability cost issues and to ask them to consider the scope of all interoperability problems in their company. We asked them to provide an estimate of the total cost of all components of interoperability costs.⁸ Their answers to this question provided the first component of our estimate of the aggregate costs. The second component of our aggregate approach was the cost incurred due to product delays, which is explained in Section 5.1.3. Together, these costs total about \$1.02 billion, as shown in Table 5-3.

Table 5-3. Summary of Annual Interoperability Costs: Aggregate Cost Approach
The aggregate cost approach provides an estimate of interoperability costs that is very similar to the cost component approach estimate.

Source of Cost	Annual Cost (\$thousands)	Percent
Interoperability cost	925,602	91
Delayed profits	90,000	9
Total	1,015,602	100

5.2.1 Aggregate Interoperability Costs

The respondents' estimates of the percent cost reductions associated with perfect interoperability varied significantly across

⁸The exact wording of the question was: "Imagine a situation in which your company experienced no data exchange problems between any of your engineering systems or with any of your customers or suppliers. In this situation, by what percentage do you think the total cost of designing and manufacturing an automobile would fall?"

sectors and among members of the same sector. For the suppliers, the estimates ranged from less than 1 percent to 10 percent. The average, weighted by the respondents' share of revenue, was about 6 percent. Estimates from the tooling suppliers ranged from 3 percent to 50 percent. The weighted average was about 13 percent. We were not able to obtain an estimate from the OEM survey respondents. Thus, the estimates provided in Table 5-3 *do not include interoperability costs for the OEMs.*⁹

Recent estimates of the cost of a major redesign of a new automobile are about \$2.5 billion (See Section 1, page 2). We assumed that a minor redesign costs about 10 percent of a major redesign. With about 12 major redesigns and 8 minor redesigns per year, the auto industry spends about \$32 billion per year on product and factory redesign. To obtain the interoperability cost estimate provided in Table 5-3, we multiplied the weighted average percent decrease in cost for each sector by that sector's share of these annual development costs.¹⁰

5.2.2 Aggregate Delay Costs

The interoperability costs shown in the first row of Table 5-3 do not include the lost profit due to delays caused by imperfect interoperability. Thus, we added our estimates of delay costs, as explained in Section 5.1.3, to the aggregate estimates of interoperability costs explained in Section 5.2.1.

5.3 SUMMARY AND DISCUSSION

Our two approaches to estimating the cost of interoperability produced very similar estimates. The cost component approach estimates that interoperability costs are about \$1.05 billion per year, while the aggregate cost approach leads to an estimate of about \$1.02 billion per year—a difference of about 3 percent. The similarity of these estimates provides some assurance that the

⁹ OEM delay costs are included in Table 5-3.

¹⁰ We assumed that product development costs are allocated among the three major sectors of the automobile supply chain (OEMs, suppliers, and tooling suppliers) according to their shares of total industry revenue. Thus, we assumed that OEMs incur 56 percent of development costs; suppliers incur 43 percent of development costs, and tooling suppliers incur 1 percent of development costs. We calculated their interoperability cost by multiplying their share of development cost by their estimated percent decrease in cost.

Although our two methods for estimating interoperability cost produced similar estimates, the aggregate cost approach does not include a potentially significant portion of OEM costs.

respondents to our survey were consistent with respect to their answers and provides evidence that the estimates are credible.

However, recall that the aggregate cost approach does not include estimates of the reduction of costs from the OEMs. In the cost component approach, over \$250 million of avoidance and mitigating costs were attributed to the OEMs, yet the OEM respondents to our survey would not provide an aggregate estimate. Thus, we might assume that, if we were able to obtain an aggregate estimate from the OEMs, the interoperability costs estimated using the aggregate cost approach might be at least 25 percent higher than that of the cost component approach.

Higher costs using the aggregate cost approach may be explained by the difficulty of detailing all of the sources of interoperability cost. For example, the cost component approach resulted in an estimate of avoidance and mitigating costs for the suppliers of only about \$240 million. However, the suppliers indicated that, with perfect interoperability, their costs would fall by, on the average, 6 percent, implying a savings of almost \$900 million using the aggregate cost approach. Thus, although these respondents had a sense of the magnitude of the costs caused by interoperability problems, they were not able to specify the actual sources of these costs in our survey using the cost component approach.

We consider this estimate of interoperability costs of the U.S. automotive supply chain to be conservative. The project's scope, time and resource constraints, and data limitations prevented us from quantifying several sources of interoperability costs. These include the following:

- ▶ **Post-manufacturing interoperability costs.** We considered only the interoperability costs involved in the design and manufacture of automobiles. Interoperability problems also occur during other phases of the product life cycle, including marketing, after-market product support, and cost analysis.
- ▶ **Interoperability costs of small suppliers.** Because of constraints on project time and resources, we quantified interoperability costs to the OEMs, large suppliers, and tooling suppliers. However, smaller suppliers may also incur some.
- ▶ **In-house investments in interoperability solutions.** Because of the unavailability of data, we were unable to quantify all of the industry's investments in the development of

interoperability solutions. These investments may be substantial. For example, GM's investment in its STEP Translator Center is not included in our estimates.

- **Costs to consumers resulting from delays.** Interoperability problems delay the introduction of new and redesigned autos. Our estimates do not include consumers' welfare losses resulting from delays in the availability of new and improved products.
- **Loss of market share resulting from delays.** We hypothesized that the U.S. auto industry could suffer a loss of market share resulting from interoperability delays, which could lead to a loss of profits to the industry. We were not able to quantify these lost profits; however, they probably are minimal. Most of our interviewees indicated that they probably did not lose market share due to delays, and that if they had they could not quantify the impact.

6

Market Barriers and Roles for NIST

Imperfect interoperability costs the U.S. automotive supply chain about \$1 billion per year. The largest component of these costs is mitigating costs, such as the labor required to repair incomplete or inaccurate models and manually enter or reenter data when other data translation methods are inadequate or not available.

Avoidance costs such as redundant software, translation outsourcing, and investments in interoperability solutions further contribute to the burden of imperfect interoperability on the industry. Finally, imperfect interoperability causes delays in the market introduction of new and redesigned models, which imposes further costs on the industry and on consumers.

These costs pose a significant challenge to the competitiveness of the U.S. automotive industry. While overseas automakers are experiencing similar problems,¹ it is widely recognized that solving interoperability problems can improve competitiveness by reducing costs and cycle time.

Other industries may also benefit from improving interoperability in design and manufacturing. Shipbuilding, aerospace, farm machinery, and construction equipment are a few of the industries that also incur costs resulting from imperfect interoperability. Our estimates of interoperability costs in the automotive supply chain are about 0.3 percent of the 1996 total value of shipments for SIC 3711 (Motor Vehicle and Car Bodies) and 3714 (Motor Vehicle Parts and Accessories) (U.S. Department of Commerce, 1998). If

¹A recent press release by Opel estimates that data translation problems alone cost the German auto industry at least several million marks per year (Strub, 1998b).

the annual interoperability cost percentage in these other industries is similar, costs could be as high as \$400 million per year.²

Currently available data translation methodologies cannot solve interoperability problems. As discussed in Section 3, single-system standardization, point-to-point translation, and neutral format translators (IGES and DXF) are costly and inadequate to significantly reduce the costs of imperfect interoperability.

STEP has a great deal of potential for improving interoperability and reducing costs. As discussed in Section 3, several organizations have tested STEP translators and found that they usually performed better than alternative translators. However, before STEP can reach its potential for solving these problems, further development and improvement of STEP translation software is required.

Despite the industrywide agreement that a neutral format such as STEP holds the best potential solution to interoperability problems (McEwan, 1995), industry has been slow to act on its own to develop and promote STEP as an interoperability solution. This section describes the source of this inaction and NIST's role in addressing these problems and in encouraging the development and diffusion of STEP.

6.1 MARKET FAILURE IN THE DEVELOPMENT OF INTEROPERABILITY SOLUTIONS

Standards and the software that embody them are infratechnologies that support technology development and application. Industry typically is reluctant to invest in infratechnologies.

Industry often is reluctant to invest in infratechnologies such as standards and software that promote the development and adoption of standards. Like many forms of R&D, infratechnologies, to varying degrees, have the characteristics of a public good. Rationing of such goods is undesirable because they are nonrival in consumption; that is, consumption of a public good does not impose costs on society because it does not reduce the amount of the good available to others. Further, the benefits of the development of these technologies are nonappropriable because it

²This scenario is based on the 1996 total value of shipments for the following SIC codes: 3721 (Aircraft); 3724 (Aircraft Engines and Engine Parts), 3728 (Aircraft Parts and Auxiliary Equipment, n.e.c.); 3761 (Guided Missiles and Space Vehicles); 3764 (Space Propulsion Units and Parts), 3769 (Space Vehicle Equipment, n.e.c.); 3731 (Ship Building and Repairing); 3523 (Farm Machinery and Equipment); and 3531 (Construction Machinery) (U.S. Department of Commerce, 1998).

is difficult or impossible to exclude those who do not pay for the infratechnologies from benefiting from them. They typically are embodied in processes, techniques, and standards, rather than in products that can be sold. As a result of these characteristics, public goods are typically underprovided by private markets as compared to their socially optimal levels of provision (Tassey, 1997).

The private sector might also underinvest in infratechnologies because of their inherent technical and market uncertainty and risk. Lack of information about the potential benefits and costs of developing an infratechnology make it difficult for decisionmakers to assess the expected value of their investment. Infratechnologies often carry high technical risk, which can also reduce private investment in favor of less risky projects, even when the expected rate of return is high (Tassey, 1997).

We spoke informally with members of the Auto Industry Action Group (AIAG) and with other industry executives to discuss the auto industry's lack of action in addressing interoperability problems. These automotive industry executives cited three major reasons for the lack of action within the industry on this issue. Below, we elaborate on these sources of market failure.

6.1.1 Nonappropriability of Benefits

Because all members of the automotive supply chain would benefit from developing and adopting a standard neutral format for PDE, no individual firm has the incentive to invest the substantial resources necessary to develop and promote the standard. Although the OEMs recognize the value of the development and adoption of such a standard, they think that the first-tier suppliers should be more active in investing in its development and adoption. However, the first-tier suppliers claim they lack the resources to make the substantial investment required. They understand that the OEMs will also benefit from improved interoperability and feel that the costs should be shared as well.

6.1.2 Technical and Market Risk

The development and diffusion of STEP throughout the automotive supply chain is limited by the risks faced by both the developers of STEP translation software and its potential users in the automotive

Both developers of STEP translation software and its users face market risk caused by the uncertainty regarding whether STEP will emerge as the industry's standard method for promoting interoperability.

supply chain. The software developers face significant technical risk because the development of STEP-compliant translation software is technically difficult and expensive. They face uncertainty during the development process regarding whether their software will be STEP-compliant.

The market risk faced by these software developers is caused by the uncertainty regarding whether STEP will emerge as the industry's standard method for promoting interoperability. Developing a standard and promoting its adoption require cooperation and agreement among many companies. Rivalries among competitors, as well as differences in their potential gain from agreeing on a standard, may prevent this cooperation. The companies that supply CAD/CAM software to the automotive industry might argue that single-system standardization is the best solution—as long as the system chosen is theirs. They are motivated to prevent the adoption of a neutral format standard because the current system of OEMs requiring neutral format exchanges feeds the industry's demand for their products. This type of competitive rivalry is a common failure of consortia attempting to solve common industry problems (Tassey, 1992).

Members of the automotive supply chain that use CAD/CAM translation software also face significant technical and market risk. They face uncertainty regarding the performance of the software with respect to the standard. Although most of the major software vendors that supply the automotive industry have released STEP translation software, users are still skeptical about the performance of the software and its value to users. Users also face uncertainty about the industry's acceptance of STEP. The value of a company's investment in STEP translation software will increase if its partners, customers, and suppliers also adopt STEP. However, as explained above, industry-wide adoption may be difficult to accomplish.

6.1.3 Need for Unbiased Expertise

Finally, developing and promoting an industry standard require unbiased expertise that the members of the automotive supply chain do not possess, individually or collectively. Because developing and promoting standards are not part of the industry's core business, they need assistance from outside experts. To maximize the acceptance of the standard by all members of the

industry, industry must believe that the experts will not promote one company's interests over another's in the process of developing and promoting standards. Thus, the experts' reputation for unbiased standards-setting and research is an important factor in the success of the standard.

6.2 POTENTIAL FUTURE ROLES FOR NIST

NIST's participation in the development of STEP can address the market failures cited above. NIST continues to support the development of STEP by acting as a catalyst in developing the standards, tools, and practices necessary to advance STEP in the automobile industry.

NIST advances the implementation of STEP in the auto industry by reducing technical and market risk and by lending its expertise to the standards development and implementation process.

By assisting in the development of STEP as an industry standard, NIST reduces the uncertainty and risk associated with the auto industry's investment in STEP. Confident that STEP will become an accepted industry standard, the OEMs, suppliers, and software developers can move ahead with STEP development and testing. In addition, by helping to demonstrate the benefits of STEP through programs such as the AutoSTEP pilot program, NIST helps to reduce industry's perceived technical risk associated with investments in STEP.

Second, NIST's activities in developing conformance testing practices helps to improve the quality of the STEP software, further reducing the technical risk to both the software industry and the auto industry users of that software. Software developers can verify that their software conforms with STEP protocols during the development stage, reducing the risk that the software will need major revisions later in the development process. Auto industry users can verify that the software they purchase conforms with STEP; this reduces the buyer's uncertainty and transaction cost.

Finally, NIST provides expertise regarding the development and implementation of standards. By continuing to participate in the development of STEP's application protocols and implementation prototypes, NIST lends credibility to the STEP development process and improves the process of standards implementation.

By participating in the development and deployment of standards-based interoperability solutions in the automobile industry, NIST

can play a significant role in reducing the \$1 billion per year cost imposed on the automotive supply chain by imperfect interoperability. Continued industry investment is necessary if STEP implementation is to minimize the costs of imperfect interoperability. In conjunction with manufacturers and software vendors, NIST can help eliminate the sources of market failure that have slowed the adoption of open, nonproprietary interoperability solutions.

References

Auto and Auto Parts: Industry Survey. January 9, 1997. "Big Three Still Dominate U.S. Market but Transplants Take Root."

Automotive Industry Action Group (AIAG). November 1997a. "Product Data Exchange in Automotive Supply Chains-AutoStep at the Midpoint." Southfield, MI: Automotive Industry Action Group.

Automotive Industry Action Group (AIAG). October 1997b. "A Snapshot of Product Development Practices in Automotive Supply Chains." Southfield, MI: Automotive Industry Action Group.

Automotive Industry Action Group (AIAG). August 1998. "Best Practices in Supply Chain Product Development." Document D-11. Southfield, MI: Automotive Industry Action Group.

Automotive News Europe. December 22, 1997. "Platforms are Fewer, but More Flexible." 2(26):6.

Automotive News. 1997a. *1997 Market Data Book*. Detroit: Marketing Services Inc.

Automotive News. June 16, 1997b. "Nissan Sets Mark for Efficiency." Detroit: Marketing Services Inc.

Automotive News. 1998a. *1998 Market Data Book*. Detroit: Marketing Services Inc.

Automotive News. March 30, 1998b. "Top 150 OEM Parts Suppliers to North America." Detroit: Marketing Services Inc.

- Automotive Parts and Accessories Association (APAA). 1998. "Standard for Exchange of Product Model Data (STEP)." Available at <<http://www.apaa.org/step.html>>.
- Brooke, Lindsay. 1998. "Unibody vs. Body-on-Frame; Sport-Utility Frames; Includes Related Articles on Low-Cost Sport Utility Vehicles and Frame Styles." *Lexis-Nexis Academic Universe* 178(1):32. <<http://web.lexis-nexis.com/univers...5=6e903b1dd9914cad980fbef0942b547a>>.
- Buchholz, Kami. 1996. "Simultaneous Engineering Saves Times and Money." 104(11):97. *Lexis-Nexis Academic Universe* 178(1):32. <<http://web.lexis-nexis.com/univers...5=97d827356946a181ae480b0eb7207546>>.
- Chilton Company. 1997. "Automotive Industries Annual Source Guide." Available at <<http://ai.chilton.net>>.
- Clark, Kim B., W. Bruce Chew, and Takahiro Fujimoto. 1987. "Product Development in the World Auto Industry." In *Brookings Papers on Economic Activity*, M.N. Baily and C. Winston (eds.), pp. 729-781. Washington, DC: The Brookings Institution.
- Chrysler Corp. January 23, 1998. Annual Report on Form 10K for year ended December 31, 1997. Edgar Database. <<http://www.sec.gov/Archives/edgar/data/791269/0000950124-98-000347.txt>>.
- Dauch, Richard E. 1993. "Passion for Manufacturing." Dearborne, MI: Society of Manufacturing Engineers.
- Doty, Rossel. 1994. "Open Systems: The Next STEP." *Action Line* January/February:30-33.
- Fine, Charles H., and Daniel Whitney. February 1996. "Is the Make or Buy Decision Process a Core Competitiveness?" Working paper. Cambridge, MA: MIT Center for Technology, Policy, and Industrial Development.
- Fleischer, Mitchell. March 1997. "STEP Update." *Automotive Manufacturing and Production* 109(3):22.
- Fleischer, Mitchell, Fredrick Nicholas, and Thomas Phelps. 1997. *AutoSTEP Case Study Report: Costs of Multiple CAD Systems*. Southfield, MI: Automotive Industry Action Group (AIAG).

- Fleischer, Mitchell, Thomas Phelps, and Michael Ensing. March 12, 1991. *CAD/CAM Data Problems and Costs in the Tool and Die Industry*. A Report on a Study Conducted for the Michigan Modernization Service by Industrial Technology Institute and the Detroit Chapter of the National Tooling and Machine Association.
- Flynn, Michael S., Bruce M. Belzowski, Bram Bluestein, Michael Ger, Manfred Tuerks, and John Waraniak. 1996. "The 21st Century Supply Chain: Changing Roles, Responsibilities and Relationships in the Automotive Industry." Chicago: A.T. Kearney, Inc.
- Ford Motor Co. March 18, 1998. Annual Report on Form 10K for year ended December 31, 1997. Edgar Database. <<http://www.sec.gov/Archives/edgar/data/37996/0000037996-98-000014.txt>>.
- Frechette, Simon. 1997. "STEP Implementation: Solid Model Exchange Results in the AutoSTEP Pilot Project." *Agility and Global Competition* 1(3):1-12.
- Frechette, Simon. June 23, 1998. "STEP Testing and Certifications." Presentation made at STEP Success Day sponsored by AIAG and PDES, Inc.
- Gale Research Inc. 1997. *Ward's Business Directory of U.S. Private & Public Companies, 1998*. Detroit: Gale Research Inc.
- Garcia, Tom, NTMA, personal communication with Alan O'Connor, Research Triangle Institute, October 2, 1998.
- General Motors Corp. March 20, 1998. Annual Report on Form 10K for year ended December 31, 1997. Edgar Database. <<http://www.sec.gov/Archives/edgar/data/40730/0000950124-98-001456.txt>>.
- Greenwald, John. 1998. "Bigger—The New '99 Models Feature High-Tech Marvels and Some of the Best Price Value in Years." *Time* 152(18).
- Hausman, Jerry. 1997. "The Effect of New Services in Telecommunication." MIT Working Paper.
- Hoover's Inc. 1998. *Hoover's Company Capsules*. Austin, TX: Hoover's Inc.
- Information Access Corporation. 1998. Business Index [computer file]. Foster City, CA: Information Access Corporation.

IRN, Inc. December 1997. "Product Life Cycles." Grand Rapids, MI.

Jost, Kevin. 1998. "Chrysler Redesigns Its Large Cars for 1998." *Lexis-Nexis Academic Universe* 106(1):10. <<http://web.lexis-nexis.com/univers...5=21777aca18ea2177704ce765373ec3d>>.

Leech, David P., and Albert N. Link. April 1995. *An Economic Evaluation of NIST's Research in Real-time Control System (RCS) Architecture: A Case Study Approach*. 95-2 Planning Report. Arlington, VA: TASC, Inc.

Link, Albert N. November 1995. *An Economic Evaluation of the Spectral Irradiance Standard*. 95-5 Planning Report.

Martin, Norman. 1998. "Putting the Tools to Work; Automobile Company Design Platforms; Includes Related Article on American Manufacturers." *Lexis-Nexis Academic Universe* 178(9):105. <<http://web.lexis-nexis.com/univers...5=7ae9d52b10e7e852d5d723e0b188cc40>>.

McEwan, I. January 1995. "In STEP with Suppliers: GM's Perspective on Product Data Exchange." Excerpt from a speech given at AutoFact '94. PRONews. <http://www.scra.org/uspro//events/gm_persp.html>.

National Institute of Standards and Technology (NIST). 1997. "Cost Modeling: Economic Loss Due to CAD/CAM File Incompatibility in the Automotive Industry." NIST presentation.

Office of Management and Budget. 1995. "Guidelines and Discount Rates for Benefit-Cost Analysis of Federal Programs." Memorandum for Heads of Executive Departments and Establishments. OMB Circular No. A-94, Revised.

PDES, Inc. 1997a. "Boeing Implements STEP as Production Exchange Process with Three Engine Companies." <http://www.scra.org/pdesinc/boeing_press.html>. News release dated August 22, 1997.

PDES, Inc. 1997b. "Delco Electronics Corporation Successfully Implements STEP for Internal Data Exchange." <http://www.scra.org/pdesinc/delco_press.html>. News release dated November 6, 1997.

PDES, Inc. 1997c. "General Motors STEP Translation Center." <http://www.scra.org/pdesinc/pilots/step_tran.html>.

- PDES, Inc. 1998. "Results of STEP Testing in the U.S. Automotive Industry." Summary sheet.
- Phelan, Mark. 1997. "Sprechen Sie Megasupplier." *Automotive Industries* June:71-75.
- Sawant, A.V., and J.N. Nazemetz. 1998. "Impediments to Data Exchange and Use of STEP for Data Exchange." Paper developed under the Computer Assisted Technology Transfer (CATT) research program. Contract number F34601-95-D-00376. Oklahoma State University working paper.
- Smith, Bradford. 1989. "Product Data Exchange: The PDES Project—Status and Objectives." NISTIR 4165. Gaithersburg, MD: National Institute of Standards and Technology. <<http://www.mel.nist.gov/msidlibrary/summary/8921.html>>.
- Sorge, Marjorie. 1998. "Ford Finds Its Global Focus." *Lexis-Nexis Academic Universe* <<http://web.lexis-nexis.com/univers...5=0f229e4b10ecf10cfe2cc2b21cb8251f>>.
- Strub, Mike. 1998a. "Get in STEP." *Action Line* January/February:16-18.
- Strub, Mike. October 6, 1998b. Memorandum to AutoSTEP exploder.
- Target*. 1994. "Are You Prepared for the Information Based Global Economy? STEP Towards the Future." *Target* 10(1):30.
- Tassey, Gregory. 1992. *Technology Infrastructure and Competitive Position*. Norwell, MA: Kluwer Academic Publishers.
- Tassey, Gregory. 1997. *The Economics of R&D Policy*. Westport, CT: Quorum Books.
- U.S. Department of Commerce. June 1995. *1992 Census of Manufactures*. MC92-I-35H and MC92-I-35H. Washington, DC: U.S. Government Printing Office.
- U.S. Department of Commerce. February 1998. *1996 Annual Survey of Manufactures*. M96(AS)-1. Washington, DC: U.S. Government Printing Office.
- U.S. Department of Commerce, Bureau of Economic Analysis (BEA). 1998. "National Accounts Data." Washington, DC: Bureau of Economic Analysis. <<http://www.bea.doc/bea/dn/nipbtbl-d.htm>>.

- U.S. Department of Labor (DOL). 1996a. "Occupational Compensation Survey. National Summary, 1996". Bulletin 2497. Bureau of Labor Statistics. Washington DC.
- U.S. Department of Labor (DOL). 1996b. "Employer Costs for Employee Compensation – March 1996". News Release dated October 10, 1996. Bureau of Labor Statistics. Washington DC.
- Ward's Communications. 1997. *Ward's Automotive Yearbook*. 59th Edition. Detroit: Ward's Communications.
- Whitney, Daniel. October 1995. *State of the Art in the United States of CAD Methodologies for Product Development*. Final report under grants from Office of Naval Research and the National Science Foundation. Cambridge, MA: MIT, Center for Technology, Policy and Industrial Development.
- Womack, James P. 1989. "The U.S. Automobile Industry in an Era of International Competition: Performance and Prospects." MIT Commission on the Industrial Productivity working paper.
- Womack, James P., Daniel T. Jones, and Daniel Roos. 1990. *The Machine that Changed the World*. New York: Rawson Associates.