

2017

## Exploring the Function of Exon 7 in Drosophila Cacophony in Relation to ALS

Jasmine E. Ahrar  
*Portland State University*

Let us know how access to this document benefits you.

Follow this and additional works at: <https://pdxscholar.library.pdx.edu/honorsthesis>

---

### Recommended Citation

Ahrar, Jasmine E., "Exploring the Function of Exon 7 in Drosophila Cacophony in Relation to ALS" (2017). *University Honors Theses*. Paper 423.

[10.15760/honors.419](https://pdxscholar.library.pdx.edu/honors/419)

This Thesis is brought to you for free and open access. It has been accepted for inclusion in University Honors Theses by an authorized administrator of PDXScholar. For more information, please contact [pdxscholar@pdx.edu](mailto:pdxscholar@pdx.edu).

Exploring the Function of Exon 7 in Drosophila Cacophony in Relation to ALS

By

Jasmine Ahrar

An undergraduate honors thesis submitted in partial fulfillment of the

requirements for the degree of

Bachelor of Science

in

University Honors

and

Science

Thesis Adviser

David B. Morton, PhD

Portland State University

2017

## **Introduction**

Amyotrophic lateral sclerosis, also known as ALS, is a progressive neurodegenerative disease that affects nerve cells in the brain and spinal cord and has no known cure or effective treatment. A well-known symptom of ALS is the gradual onset of painless progressive muscle weakness, eventually reaching the lungs resulting in the inability to breath. After diagnosis, the average life expectancy of a person is only two to five years. This disease is extremely impacting as more than 5,600 people in the United States are diagnosed with ALS each year, and it is estimated that over 30,000 Americans have ALS at any given time (“ALS Association,” 2016).

ALS, along with Alzheimer’s disease, Parkinson’s disease, and Huntington’s disease, is now known to be associated with defects in the TAR DNA-binding protein named TDP-43 (Geser et al., 2009). In motor neurons of those affected by ALS, these defects include the aggregation of TDP-43 in the cytoplasm and loss from the nucleus (Neumann et al., 2006). Part of the clinical symptoms of ALS in humans could be due to either increased presence of TDP-43 in the cytoplasm as aggregates (gain of function) or decreased presence the nucleus (loss of function), or a combination of both (Hazelett et al., 2012). Using *Drosophila melanogaster*, the Morton Lab has used the TDP-43 ortholog, TBPH, to confirm that loss of TBPH results in adult lethality, reduced larval locomotion (Diaper et al., 2013; Feiguin et al., 2009; Hazelett et al., 2012), as well as defective neuromuscular physiology (Diaper et al., 2013).

TDP-43 has many cellular roles, one of them being a regulator for splicing and transcription (Buratti & Baralle, 2010). With regards to splicing, analysis of the RNA sequencing data of the mutant flies from the loss function experiments identified a number

of potentially important target genes, including the *Drosophila* ortholog of the  $Ca_v2$  channel, *cacophony* (*cac*) (Hazelett et al., 2012).

Other loss of function studies in mice have shown that the transcripts of the calcium channels are potential targets for TDP-43 (Polymenidou et al., 2011). In the Morton Lab fly model for TDP-43 loss of function (TBPH null), loss of TBPH results in reduced levels of *cacophony* (Chang et al., 2014). The loss of function model showed late pupal lethality, and defective larval crawling that can be rescued by expressing *cacophony* selectively in motor neurons, as well as rescuing with TBPH (Chang et al., 2014). Reduced levels of *cacophony* and altered splicing due to the loss of TBPH, and the presence of this protein at the active zone of the neuromuscular junction suggest that *cacophony* is a target for TDP-43, and is potentially connected to motor neuron degradation in patients with ALS (Kawasaki, Zou, Xu, & Ordway, 2004).

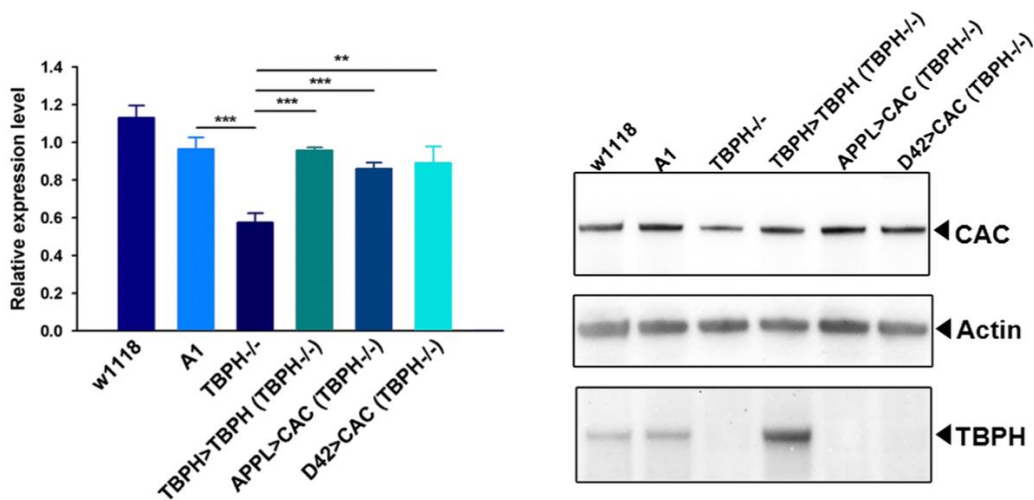

**Figure 1: TBPH null flies show decreased relative expression of *cacophony* compared to wild type flies, rescued by TBPH, as well as APPL and D42 driving *cacophony* (Chang et al., 2014).**

Altered RNA splicing seen in TBPH null flies directly resulted in a lower level of transcripts that contain exon 7 (Chang et al., 2014). Exon 7 is believed to code for a section

of the cytoplasmic C-terminal tail of *cacophony*, a region that is “known to affect inactivation and calcium regulation” (Macleod et al., 2006). “Of the 15 predicted *cacophony* transcripts on FlyBase only one, *cac-RM*, lacks exon 7 suggesting it plays a significant physiological role,” though the specific function is unknown (Chang et al., 2014).

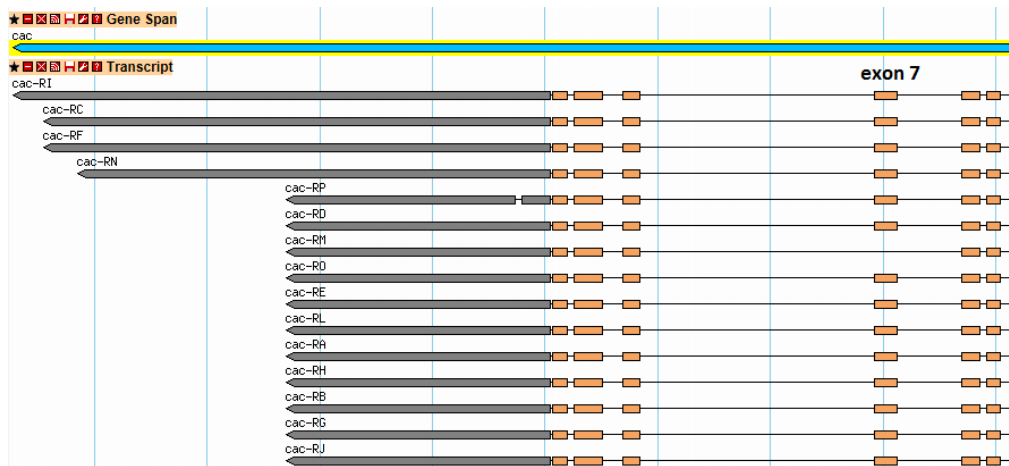

**Figure 2: Predicted transcripts of *cacophony* gene, with only one (*cac-RM*) lacking exon 7 (FlyBase).**

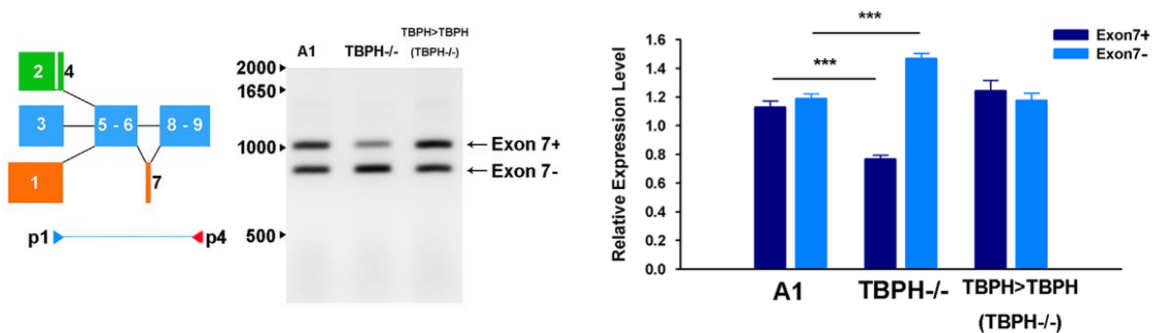

**Figure 3: Expression levels of exon 7 are decreased in TBPH null flies (Chang et al., 2014).**

Absence of TBPH results in larvae that have reduced locomotion and are late pupal lethal. Due to the lethality, adult phenotypes have not been assessed, however it is known that these mutants have altered splicing and an increased number of transcripts that lack exon 7, as well as reduced *cacophony* levels. Using CRISPR/Cas9 mediated genome editing, the Morton Lab has also generated flies that completely lack exon 7 in *cacophony*. These

flies are adult viable, have defective larval crawling and reduced levels of cacophony protein (Morton, 2016). This study aims to assess the phenotypes of adult flies that lack exon 7 to better understand its functionality, and determine if a loss of exon 7 in the cacophony transcript causes the locomotion defects observed in TBPH null mutants.

## **Methods**

### **Fly keeping:**

All flies were reared at 25°C using standard procedures (Roote & Prokop, 2013).

### **Generation exon 7(-) Fly Lines:**

The Morton Lab generated flies that completely lack exon 7 in cacophony, using CRISPR/Cas9 mediated genome editing. The exon 7 portion was replaced by DsRed, resulting in exon 7(-) flies identifiable by white eyes and eye specific DsRed. These flies are adult viable, have defective larval crawling and reduced levels of cacophony protein (Morton, 2016). Two lines were successfully generated, called I2-6 and I2-8, both used in this study determine the phenotype of exon 7(-) by comparing activity and survival with wild type flies.

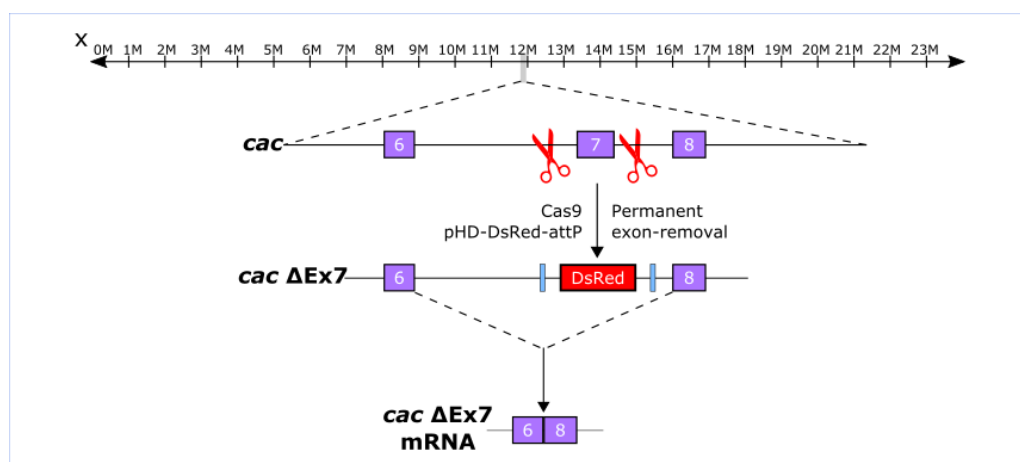

**Figure 4: Schematic diagram of drosophila genome (edited portion), showing the removal of exon 7 and replacement with DsRed (Alexander Law).**

### **Fly Stocks:**

The following GAL4 drivers, provided by the Bloomington stock center, were used to express cacophony in their corresponding neurons: APPL-GAL4 which drives expression in all neurons, D42-GAL4, a motor neuron driver, OK6-GAL4, a more specific motor neuron driver, Cha-GAL4, a sensory and interneuron driver, as well as an x-duplication line which includes the full length of the cacophony genome (Vanderwerf et al., 2015; Morton, 2016). Each of these drivers is present on one of the four drosophila chromosomes.

*Drosophila melanogaster* has one pair of sex chromosomes and three pairs of autosomes, however the fourth chromosome harbors very few genes and plays a negligible role in this study so it will not be considered here (Roote & Prokop, 2013). Second and third chromosome balancer lines were also provided by the Bloomington stock center. Second balancer chromosome is named CyO and carries the marker Cy on one chromosome and the Gla marker on the other. The third chromosome balancer carries both Tb and Sb on one chromosome, and the other (non-balancer) carries the Dr marker.

Fly Line	Genotypes (female, male)
I2-6/I2-8	$\frac{I2-6/8}{I2-6/8}; \frac{+}{+}; \frac{+}{+}, \frac{I2-6/8}{y}; \frac{+}{+}; \frac{+}{+}$
APPL-GAL4	$\frac{APPL}{APPL}; \frac{+}{+}; \frac{+}{+}, \frac{APPL}{y}; \frac{+}{+}; \frac{+}{+}$
D42-GAL4	$\frac{+}{+}; \frac{+}{+}; \frac{D42}{D42}, \frac{+}{y}; \frac{+}{+}; \frac{D42}{D42}$
OK6-GAL4	$\frac{+}{+}; \frac{OK6}{Ok6}; \frac{+}{+}, \frac{+}{y}; \frac{OK6}{OK6}; \frac{+}{+}$
Cha-GAL4	$\frac{+}{+}; \frac{Cha}{Cha}; \frac{+}{+}, \frac{+}{y}; \frac{Cha}{Cha}; \frac{+}{+}$
x-duplication	$\frac{+}{+}; \frac{+}{+}; \frac{dup}{dup}, \frac{+}{y}; \frac{+}{+}; \frac{dup}{dup}$
II Chromosome Balancer	$\frac{+}{+}; \frac{Cyo}{Gla}; \frac{+}{+}, \frac{+}{y}; \frac{Cyo}{Gla}; \frac{+}{+}$
III Chromosome Balancer	$\frac{+}{+}; \frac{+}{+}; \frac{Tb}{Sb}, \frac{+}{y}; \frac{+}{+}; \frac{Tb}{Sb}$

**Table 1: Fly lines used in this study, showing the presence of I2-6/8, and APPL on the first chromosome, OK6-GAL4, Cha-GAL4, and Cyo/Gla on the second, and D42-GAL4, x-duplication, and Tb/Sb on the third.**

## Mating Schemes:

A mating scheme was designed using balancer lines to ensure the examined flies carried the correct genotypes on each chromosome. For each experiment, crosses were made to generate flies that carry the exon 7(-) deletion plus the specific GAL4 driver and UAS-cacophony.

The provided balancers were crossed with exon 7(-) flies to create lines with homogeneous I2-6/I2-8 and the balancer/marker gene. The resulting line was identifiable by eye specific DsRed, curly wings and glassy eyes.

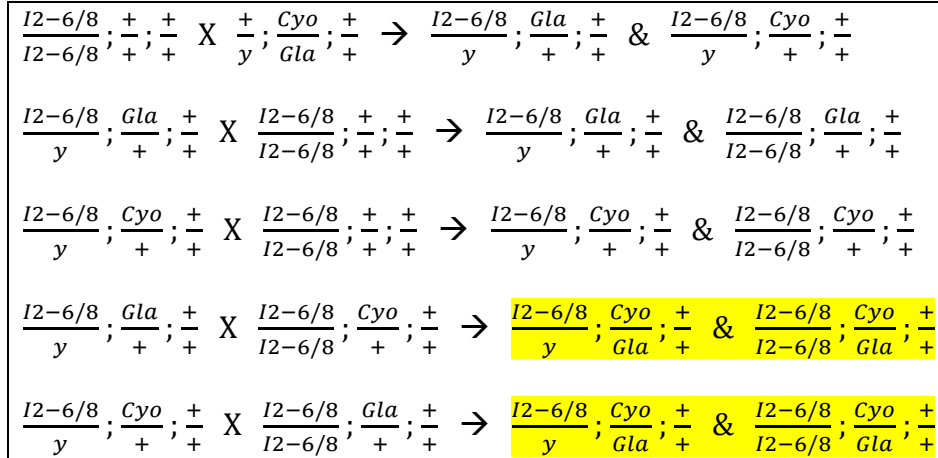

**Figure 5: Mating scheme for homogenous I2-6/I2-8 with second chromosome balancer. The third chromosome balancer line with exon 7 deletion was generated in a similar manner.**

Lines carrying the various UAS-GAL4 drivers and the exon 7 deletion were also generated. These flies were identifiable by colored eyes and eye specific DsRed.

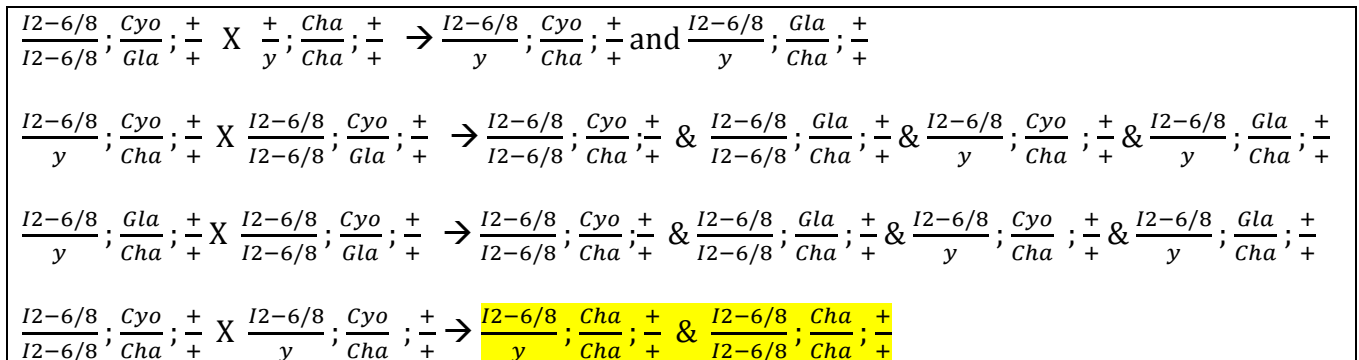



**Figure 6: Mating scheme for homogenous I2-6/I2-8 and Cha-GAL4. Generation of I2-6/I2-8 with D42 and OK6 were carried out in a similar manner.**

APPL-GAL4 is on the x-chromosome, requiring recombination for the presence of both APPL and exon 7(-). These flies were identifiable by colored eyes and eye specific DsRed.

$$\begin{array}{l}
 \frac{I2-6/8}{y}; \frac{+}{+}; \frac{+}{+} \times \frac{APPL}{APPL}; \frac{+}{+}; \frac{+}{+} \rightarrow \frac{APPL}{I2-6/8}; \frac{+}{+}; \frac{+}{+} \\
 \\
 \frac{APPL}{I2-6/8}; \frac{+}{+}; \frac{+}{+} \times \frac{+}{y}; \frac{+}{+}; \frac{+}{+} \rightarrow \frac{APPL, I2-6/8}{+}; \frac{+}{+}; \frac{+}{+} \quad \& \quad \frac{APPL, I2-6/8}{y}; \frac{+}{+}; \frac{+}{+} \quad \text{*Recombination} \\
 \\
 \frac{APPL, I2-6/8}{+}; \frac{+}{+}; \frac{+}{+} \times \frac{APPL, I2-6/8}{y}; \frac{+}{+}; \frac{+}{+} \rightarrow \frac{APPL, I2-6/8}{APPL, I2-6/8}; \frac{+}{+}; \frac{+}{+} \quad \& \quad \frac{APPL, I2-6/8}{y}; \frac{+}{+}; \frac{+}{+}
 \end{array}$$

**Figure 7: Mating scheme for homogenous I2-6/I2-8 an APPL.**

A fly line with cacophony and exon 7(-) was generated, identifiable by colored eyes and eye specific DsRed.

$$\begin{array}{l}
 \frac{I2-6/8}{I2-6/8}; \frac{+}{+}; \frac{Dr}{Tb} \times \frac{+}{y}; \frac{+}{+}; \frac{cac}{cac} \rightarrow \frac{I2-6/8}{y}; \frac{+}{+}; \frac{Dr}{cac} \quad \& \quad \frac{I2-6/8}{y}; \frac{+}{+}; \frac{Tb}{cac} \\
 \\
 \frac{I2-6/8}{y}; \frac{+}{+}; \frac{Dr}{cac} \times \frac{I2-6/8}{I2-6/8}; \frac{+}{+}; \frac{Dr}{Tb} \rightarrow \frac{I2-6/8}{I2-6/8}; \frac{+}{+}; \frac{Dr}{cac} \quad \& \quad \frac{I2-6/8}{I2-6/8}; \frac{+}{+}; \frac{Tb}{cac} \quad \& \quad \frac{I2-6/8}{y}; \frac{+}{+}; \frac{Dr}{cac} \quad \& \quad \frac{I2-6/8}{y}; \frac{+}{+}; \frac{Tb}{cac} \\
 \\
 \frac{I2-6/8}{y}; \frac{+}{+}; \frac{Tb}{cac} \times \frac{I2-6/8}{I2-6/8}; \frac{+}{+}; \frac{Dr}{Tb} \rightarrow \frac{I2-6/8}{I2-6/8}; \frac{+}{+}; \frac{Dr}{cac} \quad \& \quad \frac{I2-6/8}{I2-6/8}; \frac{+}{+}; \frac{Tb}{cac} \quad \& \quad \frac{I2-6/8}{y}; \frac{+}{+}; \frac{Dr}{cac} \quad \& \quad \frac{I2-6/8}{y}; \frac{+}{+}; \frac{Tb}{cac} \\
 \\
 \frac{I2-6/8}{I2-6/8}; \frac{+}{+}; \frac{Tb}{cac} \times \frac{I2-6/8}{y}; \frac{+}{+}; \frac{Tb}{cac} \rightarrow \frac{I2-6/8}{y}; \frac{+}{+}; \frac{cac}{cac} \quad \& \quad \frac{I2-6/8}{I2-6/8}; \frac{+}{+}; \frac{cac}{cac}
 \end{array}$$

**Figure 8: Mating scheme for homogenous I2-6/I2-8 and cac.**

**Flies used for locomotion assays:**

The above resulting I2-6/8-GAL4 driver lines were crossed with the respective I2-6/8 cacophony line, resulting in homogenous I2-6/8 with GAL4 drivers and cacophony. The x-duplication line was simply crossed with I2-6/8 and the progeny was examined. Control lines were produced by crossing each parental line with wild type flies on order to compare with heterogeneous genotypes for a more accurate control.

<b>Rescue Line:</b>	<b>Control Lines:</b>	
$\frac{I2-6/8}{y}, \frac{+}{+}, \frac{cac}{+}$	$\frac{APPL, I2-6/8}{y}, \frac{+}{+}, \frac{+}{+}$	$\frac{I2-6/8}{y}, \frac{+}{+}, \frac{cac}{+}$
$\frac{I2-6/8}{y}, \frac{Cha}{+}, \frac{cac}{+}$	$\frac{I2-6/8}{y}, \frac{Cha}{+}, \frac{+}{+}$	$\frac{I2-6/8}{y}, \frac{+}{+}, \frac{cac}{+}$
$\frac{I2-6/8}{y}, \frac{+}{+}, \frac{D42}{cac}$	$\frac{I2-6/8}{y}, \frac{Cha}{+}, \frac{+}{+}$	$\frac{I2-6/8}{y}, \frac{+}{+}, \frac{cac}{+}$
$\frac{I2-6/8}{y}, \frac{+}{+}, \frac{dup}{+}$	$\frac{+}{y}, \frac{+}{+}, \frac{dup}{+}$	

**Table 2: Flies (genotypes) used for locomotion assays.**

**Locomotion Assays:**

To monitor activity patterns and survival of male flies, a bioactivity monitoring system made by TriKinetics was used. Within a 25°C incubator, each fly was placed in a 65-mm long tube containing an infrared beam at the midline, as flies crossed the midline photo beam breaks are recorded by a computer. At one end of the tube was a fly food solution of 5% sucrose and 2% agarose. Flies treated with caffeine were given the same solution with 25mmol of caffeine. Locomotion was measured by how many times the flies cross the beam. Time of death was determined by the last time of activity prior to 24 hours of inactivity.

## Results

Previous studies show I2-8 and I2-6 flies have reduced levels of cacophony protein as well as reduced larval locomotion. This study explores activity and survival in adult flies. The results shown in Figure 5 demonstrate that adults with the exon 7(-) genotype have reduced locomotion compared to wild type flies, as well as decreased ability to survive with exposure to 25mmol of caffeine. It was intended to assess the activity of flies with caffeine, but the animals died too quickly under those conditions to get sufficient data.

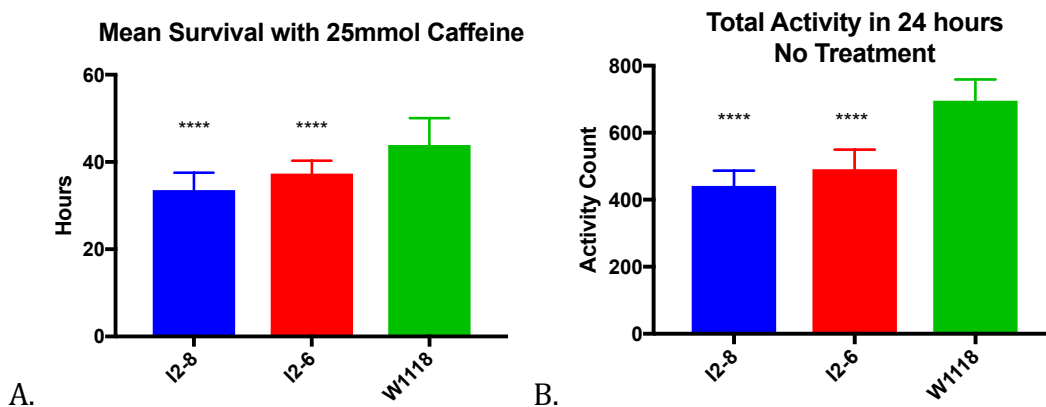

**Figure 5: Exon 7(-) flies show reduced activity without treatment and decreased survival with caffeinated food compared to control flies, using ANOVA analysis and Dunnett's multiple comparisons test comparing both lines to W1118 where \*\*\*\*p<0.0001. A) Survival is significantly reduced in I2-8 flies (n=32) and in I2-6 flies (n=37), compared to W1118 flies (n=32). B) Activity with no treatment was significantly reduced in I2-8 (n=32) and in I2-6 flies (n=36), compared to W1118 flies (n=32).**

Whether these defects are due to absence of exon 7 and decreased levels of cacophony, in all cells, motor neurons, sensory neurons, or all neurons, is further explored by driving or duplicating the cacophony genome in those cell categories. Duplicating the cacophony genome and theoretically restoring the splicing pattern and expression levels of cacophony in all cell types was first assessed.

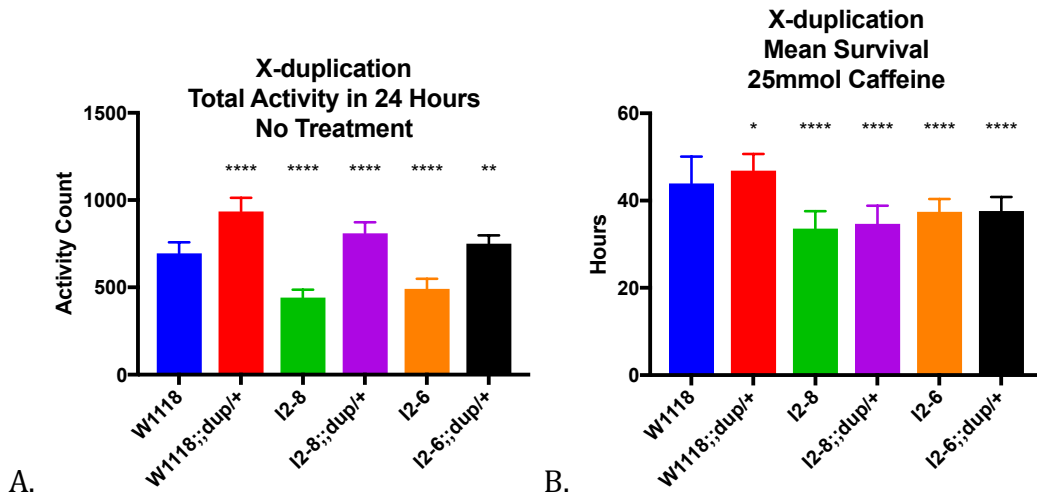

**Figure 6: Rescue results for X-duplication flies with ANOVA analysis and Dunnett's multiple comparisons test, comparing all lines with W1118 where \*\*\*\* $p < 0.0001$ , \*\* $p = 0.0016$ , \* $p < 0.0255$ . A) W1118 flies with duplicated cacophony (n= 36) show significantly increased activity compared to W1118 (n=32). I2-8 flies with duplication (n=24) show rescued activity, though significantly different from W1118. I2-6 flies with duplication (n=34) show rescued activity levels compared to W1118, though significantly different. B) W1118 flies with duplicated cacophony show increased survival (n=36) compared to W1118 (n=32). I2-8 (n=25) and I2-6 (n=34) flies with duplicated cacophony do not show rescued survival.**

The finding that W1118 flies have increased activity with the duplication confirms that an extra copy of the cacophony genome increases activity in Drosophila. W1118 also has increased survival with the x-duplication indicating that cacophony levels may affect the ability of these animals to survive caffeine. Decreased activity levels seen in I2-8 and I2-6 is rescued in both lines with an x-duplication, though levels are significantly different from W1118. This result suggests that the reduced activity seen in I2-8 and I2-6 is due to the absence of exon 7, specifically whether the defects are due to the absence itself or the resulting reduced level of cacophony cannot be determined by these results. This would require further research.

The duplication rescue restores cacophony expression in all cells and rescues locomotion defects in flies lacking exon 7. The follow-up experiments to this study will test the effect of using the following UAS-GAL4 drivers for cacophony: APPL-GAL4 which drives expression in all neurons, D42-GAL4, a motor neuron driver, and Cha-GAL4, a sensory and interneuron driver. The following data shows preliminary results of rescue experiments. Between 14 and 22 subjects were used per experiment, and data is not analyzed for statistical significance as values may change with future trials.

APPL driving cacophony preliminary results show increased activity and survival in both I2-6 and I2-8 lines, however, the levels in I2-6 are noticeably higher. If this trend continues with further trials, it may suggest that there are differences in the I2-6 and I2-8 background. Further, it is interesting that in all three experiments, the I2 lines show increased activity and survival with only UAS cacophony and no GAL4 driver. This may suggest something else is going on with the background of the I2 cacophony stocks, and will be evaluated in further trials.

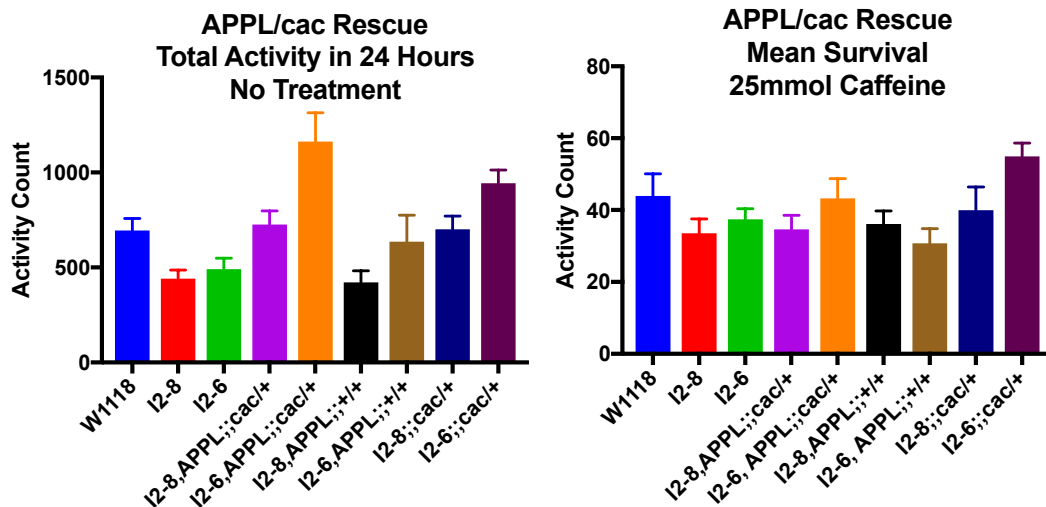

Figure 7: Preliminary data for APPL driving cacophony expression in all neurons

The D42 rescue has thus far only been conducted with I2-6 flies. Preliminary results show an increase in activity that is greater than the W1118 control line, but not the same for survival.

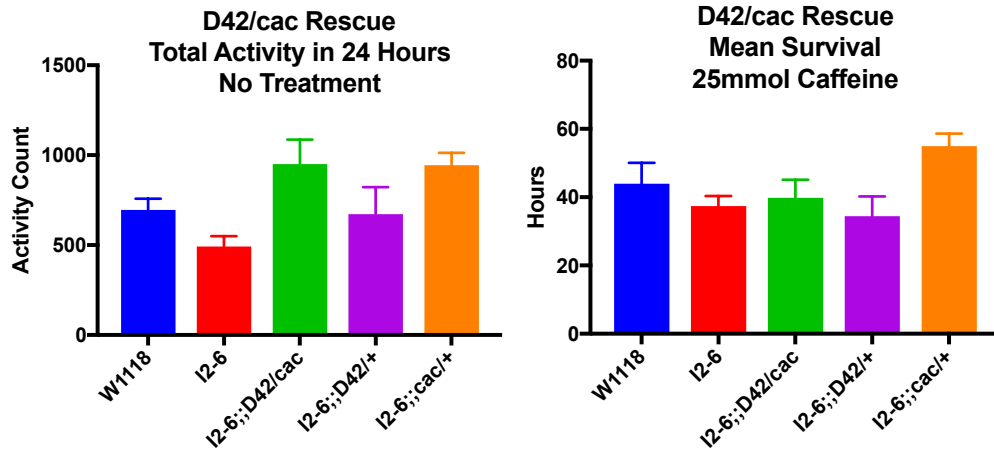

Figure 8: Preliminary data for D42 driving cacophony in motor neurons in I2-6 flies

Cha driving cacophony expression in sensory and interneurons, so far shows a difference in the I2-6 and I2-8 levels of activity and survival.

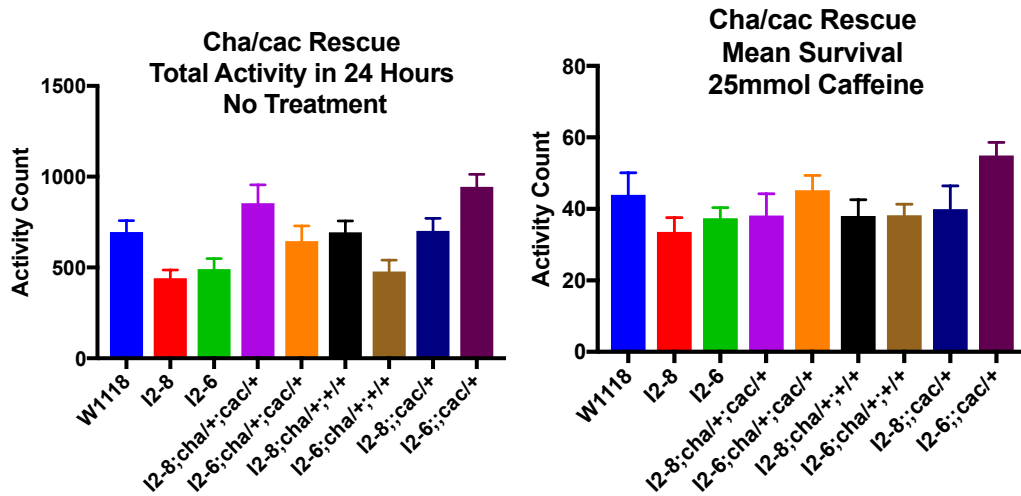

Figure 9: Preliminary data for Cha driving cacophony expression in sensory and interneurons

In terms of the assessment that is to be made about whether the defects of I2 flies are due to absence of exon 7 and decreased levels of cacophony, in all cells, all neurons,

motor neurons, sensory neurons, no assertion can be made with the preliminary data at hand. Further trials may show distinctions between activity and survival between lines driving cacophony expression in different sets of neurons. If there is a difference, more will be known about which neurons are most affected by the exon 7 deletion.

### **Discussion:**

According to researchers at Oregon Health and Science University, “as cacophony mediates some of the physiological effects of TBPH loss, it is a good candidate to explore as a pharmacological target for ALS therapies” (Chang et al., 2014). A stipulation to this is that it is unknown whether there is a change in exon 7 in ALS patients. However, we do know that other animal models suggest that cacophony is a target gene (Morton, 2016). The data collected in this study is a valuable contribution to what is currently known about the causative events in ALS if similar effects of cacophony or exon 7 is found in human patients, this could be helpful in developing treatment methods.

Further studies need to be conducted in order to determine the specific function of exon 7 in its involvement with ALS. This study demonstrates that a lack of this exon results in reduced locomotion and is rescued by increased cacophony expression. Whether exon 7 has other symptomatic affects that are unrelated to cacophony expression need to be explored.

### **Acknowledgements**

I wish to thank Kayly Lembke, Alexander Law, and Jer-Cherng Chang for all of their help throughout this process. A special thanks to Dr. David Morton for giving me the opportunity to be a part of The Morton Lab and being an extremely helpful and available thesis advisor.

**Works Cited**



ALS Association. (2016). Retrieved May 6, 2016, from <http://www.alsa.org/about-als/what-is-als.html>

Buratti, E., & Baralle, F. E. (2010). The multiple roles of TDP-43 in pre-mRNA processing and gene expression regulation. *RNA Biology*, 7(4), 420–429.  
<https://doi.org/10.4161/rna.7.4.12205>

Chang, J.-C., Hazelett, D. J., Stewart, J. A., & Morton, D. B. (2014). Motor neuron expression of the voltage-gated calcium channel cacophony restores locomotion defects in a *Drosophila*, TDP-43 loss of function model of ALS. *Brain Research*, 1584, 39–51.  
<https://doi.org/10.1016/j.brainres.2013.11.019>

Diaper, D. C., Adachi, Y., Sutcliffe, B., Humphrey, D. M., Elliott, C. J. H., Stepto, A., ... Hirth, F. (2013). Loss and gain of *Drosophila* TDP-43 impair synaptic efficacy and motor control leading to age-related neurodegeneration by loss-of-function phenotypes. *Human Molecular Genetics*, 22(8), 1539–1557.  
<https://doi.org/10.1093/hmg/ddt005>

Feiguin, F., Godena, V. K., Romano, G., D'Ambrogio, A., Klima, R., & Baralle, F. E. (2009). Depletion of TDP-43 affects *Drosophila* motoneurons terminal synapsis and locomotive behavior. *FEBS Letters*, 583(10), 1586–1592.  
<https://doi.org/10.1016/j.febslet.2009.04.019>

Geser, F., Martinez-Lage, M., Robinson, J., Uryu, K., Neumann, M., Brandmeir, N. J., ... Trojanowski, J. Q. (2009). Clinical and pathological continuum of multisystem TDP-43 proteinopathies. *Archives of Neurology*, 66(2), 180–189.  
<https://doi.org/10.1001/archneurol.2008.558>

Hazelett, D. J., Chang, J.-C., Lakeland, D. L., & Morton, D. B. (2012). Comparison of Parallel High-Throughput RNA Sequencing Between Knockout of TDP-43 and Its Overexpression Reveals Primarily Nonreciprocal and Nonoverlapping Gene Expression Changes in the Central Nervous System of *Drosophila*. *G3: Genes/Genomes/Genetics*, *2*(7), 789–802. <https://doi.org/10.1534/g3.112.002998>

Kawasaki, F., Zou, B., Xu, X., & Ordway, R. W. (2004). Active Zone Localization of Presynaptic Calcium Channels Encoded by the cacophony Locus of *Drosophila*. *Journal of Neuroscience*, *24*(1), 282–285. <https://doi.org/10.1523/JNEUROSCI.3553-03.2004>

Macleod, G. T., Chen, L., Karunanithi, S., Peloquin, J. B., Atwood, H. L., McRory, J. E., ... Charlton, M. P. (2006). The *Drosophila* *cacts2* mutation reduces presynaptic Ca<sup>2+</sup> entry and defines an important element in Cav2.1 channel inactivation. *European Journal of Neuroscience*, *23*(12), 3230–3244. <https://doi.org/10.1111/j.1460-9568.2006.04873.x>

Morton, D. B. (2016). Preliminary Unpublished Data from the Morton Lab.

Neumann, M., Sampathu, D. M., Kwong, L. K., Truax, A. C., Micsenyi, M. C., Chou, T. T., ... Lee, V. M.-Y. (2006). Ubiquitinated TDP-43 in Frontotemporal Lobar Degeneration and Amyotrophic Lateral Sclerosis. *Science*, *314*(5796), 130–133. <https://doi.org/10.1126/science.1134108>

Polymenidou, M., Lagier-Tourenne, C., Hutt, K. R., Huelga, S. C., Moran, J., Liang, T. Y., ... Cleveland, D. W. (2011). Long pre-mRNA depletion and RNA missplicing contribute to neuronal vulnerability from loss of TDP-43. *Nature Neuroscience*, *14*(4), 459–468. <https://doi.org/10.1038/nn.2779>

Roote, J., & Prokop, A. (2013). How to Design a Genetic Mating Scheme: A Basic Training Package for Drosophila Genetics. *G3: Genes/Genomes/Genetics*, 3(2), 353–358.

<https://doi.org/10.1534/g3.112.004820>

Vanderwerf, S. M., Buck, D. C., Wilmarth, P. A., Sears, L. M., David, L. L., Morton, D. B., & Neve, K. A. (2015). Role for Rab10 in Methamphetamine-Induced Behavior. *PloS One*, 10(8), e0136167. <https://doi.org/10.1371/journal.pone.0136167>